



**High-temperature geothermal energy utilization in the  
context of EU climate and energy policy**  
Life cycle environmental impacts and primary energy demand

Marta Rós Karlsdóttir



**Faculty of Industrial Engineering, Mechanical Engineering  
and Computer Science  
University of Iceland  
2021**



**High-temperature geothermal energy utilization in the  
context of EU climate and energy policy**  
Life cycle environmental impacts and primary energy demand

Marta Rós Karlsdóttir

Dissertation submitted in partial fulfillment of a  
*Philosophiae Doctor* degree in Mechanical Engineering

Dctoral committee  
Dr. Ólafur Pétur Pálsson  
Dr. Halldór Pálsson  
Dr. Jukka Heinonen

Opponents  
Dr. Maria Laura Parisi  
Dr. Peter Bayer

Faculty of Industrial Engineering, Mechanical Engineering  
and Computer Science  
School of Engineering and Natural Sciences  
University of Iceland  
Reykjavik, June 2021

High-temperature geothermal energy utilization in the context of EU climate and energy policy - life cycle environmental impacts and primary energy demand  
Dissertation submitted in partial fulfillment of a *Philosophiae Doctor* degree in Mechanical engineering

Copyright © 2021 Marta Rós Karlsdóttir  
All rights reserved

Faculty of Industrial Engineering, Mechanical Engineering and Computer Science  
School of Engineering and Natural Sciences  
University of Iceland  
Tæknigarður – Dunhagi 5  
107 Reykjavík  
Iceland

Telephone: +354 525 4700

ISBN 978-9935-9579-8-6

Bibliographic information:

Marta Rós Karlsdóttir, 2021, *High-temperature geothermal energy utilization in the context of EU climate and energy policy - life cycle environmental impacts and primary energy demand*, Ph.D. dissertation, Faculty of Industrial Engineering, Mechanical Engineering and Computer Science, University of Iceland, 139 pp.

Author ORCID: <https://orcid.org/0000-0002-7750-3349>

Printing: Háskólaprent  
Reykjavík, Iceland, June 2021

# Abstract

Geothermal energy utilization contributes to less than 0.5% of the world's electricity demand and is not well represented in energy policies and environmental studies of energy systems. Research on geothermal potential and environmental impacts shows that geothermal energy can contribute to a low-carbon future and increased share of renewables in future energy systems, wherever access to geothermal resources is technically and economically feasible. Furthermore, geochemical conditions have to be favorable, as gaseous emissions are byproducts of utilizing high-temperature geothermal resources, where fluids are hotter than 150°C at 1 km depth below the surface. These include greenhouse gas (GHG) emissions that can be as high as emissions from fossil-fuelled power plants in rare instances.

The recent climate and energy targets of the EU “clean energy for all” package for the year 2030 are set to reduce GHG emissions, increase the share of renewables within the EU energy mix, increase energy efficiency, and lower demand across the energy sector. This study investigates how the current EU climate and energy policy supports high-temperature geothermal utilization in future energy systems by comparing life cycle assessment results to the 2030 targets. The methodology of life cycle assessment (LCA) was applied to a case study of a state-of-the-art, high-temperature geothermal combined heat and power plant located in Iceland. LCA provides a holistic approach to analyzing various environmental impacts, including GHG emissions and primary energy demand, which serve as a basis for the EU targets. Detailed life cycle inventory (LCI) data was collected for the study since such data is not readily available in LCA literature or databases for geothermal applications. Furthermore, different allocation methods used to divide the environmental impacts between heat and electricity were tested to observe their impacts on the overall results.

The overall results showed that life cycle GHG emissions are similar to other renewable energy technologies and thus can contribute significantly to lowering these emissions associated with energy use by replacing fossil fuels. However, due to the low thermal efficiency of electricity generation from geothermal, its increased use does not result in the desired increased energy efficiency, as measured by the EU targets in terms of primary energy demand, when added or replacing older technologies in the current energy system. However, the study results suggest that emphasis could instead be put on the non-renewable primary energy demand to ensure that renewable technologies such as geothermal utilization do not contradict the EU energy efficiency target. The study also identifies H<sub>2</sub>S emissions as a hotspot for geothermal utilization as the gas contributes to acidification and human toxicity potential. The results suggest that a barrier exists in current EU policy that may hinder geothermal energy from becoming one of the desired solutions to reach the 2030 climate and energy targets.



# Útdráttur

Framleiðsla raforku með jarðhita telur minna en 0.5% af rafmagnspörf heimsins. Sökum þessa er jarðhitanýting oftan undanskilin í stefnumótun og rannsóknum á orkukerfum. Þær rannsóknir sem til eru um nýtingarmöguleika og umhverfisáhrif jarðhita á heimsvísu benda til þess nýting hans, þar sem jarðfræðilegar og efnahagslegar forsendur eru til staðar, geti stuðlað að því að minnka losun frá orkuframleiðslu og aukið hlut endurnýjanlegra orkugjafa á kostnað jarðefnaeldsneytis. Þó eru til dæmi þess að nýting jarðhita valdi samskonar losun og nýting jarðefnaeldsneytis til orkuframleiðslu, sem bendir til mikilvægi þess að rétt skilyrði séu fyrir hendi við nýtingu slíkra auðlinda. Losun gróðurhúsalofttegunda fylgir einkum nýtingu háhita, þar sem jarðhitavökvi er um 150°C eða heitari á 1 km dýpi.

Í ný-uppfærðri orkustefnu Evrópusambandsins (ES) eru sett fram markmið um orku- og loftslagsmál. Þau eru birt sem hluti af hreinorkupakkanum (e. „clean energy for all” package) og ná til ársins 2030. Þau eiga einkum að leiða til minunar á losun gróðurhúsalofttegunda, auka hlut endurnýjanlegra orkugjafa og minka orkunotkun með bættri orkunýtingu innan ES. Þessari rannsókn er ætlað að svara hvernig, og hvort, nógildandi markmið orkustefnu ES yti undir frekari jarðhitanýtingu í Evrópu. Rannsóknin notar aðferðir vistferilsgreiningar (e. Life cycle assessment (LCA)) til þess að reikna út frumorkunýtni og kolefnisspor háhitanýtingar til samanburðar við markmiðin. Rannsóknin er byggð á raundæmi um slíka nýtingu, nánar tiltekið Hellsisheiðarvirkjun, sem er hátækni jarðvarmavirkjun sem framleiðir bæði rafmagn og varma til húshitunar. Beiting vistferilsgreiningar gefur heildrænar niðurstöður fyrir ýmis umhverfisáhrif virkjunarinnar, þar með talið kolefnisspor framleiðslunnar og frumorkukræfni hennar, sem eru lykilstærðir í markmiðum orkustefnu ES. Hluti af rannsókninni fólst í því að safna saman ítarlegu gagnasetti fyrir mismunandi hluta lífsferils virkjunarinnar (e. Life cycle inventory (LCI)), þar sem slík gögn voru ekki til reiðu fyrir háhitavirkjanir í útgefnum rannsóknum eða gagnasettum. Jafnframt voru skoðaðar mismunandi aðferðir til að skipta umhverfisáhrifum milli raforku- og varmaframleiðslunnar (e. Allocation methods) til þess að meta áhrif þeirra á kolefnisspor og frumorkukræfni beggja framleiðsluvara.

Niðurstöðurnar sýna að kolefnisspor háhitanýtingar er svipað og kolefnisspor annarra endurnýjanlegra orkugjafa, þegar aðferðum lífsferilsgreiningar er beitt við útreikningana. Þar með getur jarðhiti gegnt mikilvægu hlutverki samhliða öðrum endurnýjanlegum orkugjöfum í framtíðar orkukerfum á heimsvísu til að verjast loftslagsvánni. Hins vegar er varmanýtni slíkra virkjana lág þegar kemur að rafmagnsframleiðslu, sem gerir það að verkum að háhitanýting nær ekki að uppfylla markmið ES um aukna orkunýtni og minni frumorkunotkun. Ef horft yrði til frumorkunotkunnar af óendurnýjanlegum uppruna (e. non-renewable primary energy demand) eingöngu myndi jarðhitanýting koma afar vel út í samanburði við aðra orkugjafa. Niðurstöður rannsóknarinnar sýna einnig fram á að losun brennisteinsvetnis ( $H_2S$ ) er álagspunktur í vistferilsgreiningunni þegar þær eru bornar saman við umhverfisáhrif annarrar orkutækni. Losun  $H_2S$  telst því ein alvarlegasta aukaverkun jarðhitanýtingar og veldur hún áhrifum á súrnun (e. Acidification potential) og eitrunaráhrifum á mannfolk (e. Human toxicity potential). Komast má hjá slíkri losun með notkun hreinsunarbúnaðar við slíkar virkjanir. Ljóst er af niðurstöðunum að núverandi framsetning orkustefnu ES og markmiða henni tengdri styðja ekki nægjanlega vel við uppbyggingu jarðhitanýtingar í Evrópu.





*Dedication*

*I dedicate this work to my life cycle.*

*To my parents and grandparents that have contributed to my passion for seeking knowledge.*

*To my husband for his endless support.*

*To my three children, whom I hope to inspire to seek their passions and grow their talents –  
to never give up.*

*To geothermal energy. So mystique, so hidden, yet so present and visible. An essential natural  
resource for enabling quality of life in my home country, Iceland.*

# List of Publications

## Journal papers – Publications that directly contribute to this dissertation

### PI:

Karlsdottir, M. R., Palsson, H., Palsson, O. P., Maya-Drysdale, L. (2015). Life cycle inventory of a flash geothermal combined heat and power plant located in Iceland. *The International Journal of Life Cycle Assessment*, 1-17.

### PII:

Karlsdottir, M. R., Heinonen, J., Palsson, H., Palsson, O. P. (2020). Life cycle assessment of a geothermal combined heat and power plant based on high-temperature utilization. *Geothermics*, 84, 101727.

### PIII:

Karlsdottir, M. R., Heinonen, J., Palsson, H., Palsson, O. P. (2020). High-Temperature Geothermal Utilization in the Context of European Energy Policy - Implications and Limitations. *Energies*, 13(12), 3187.

## Conference papers – Publications that supported this dissertation

### CI:

Karlsdottir, M. R., Palsson, H., Palsson, O. P. (2010). Factors for Primary Energy Efficiency and CO<sub>2</sub> Emission of Geothermal Power Production. *In Proc. World Geothermal Congress*, Bali, Indonesia, April 25-29, 2010.

### CII:

Karlsdottir, M. R., Palsson, O. P., Palsson, H (2010). LCA of Combined Heat and Power Production at Hellisheidi Geothermal Power Plant with Focus on Primary Energy Efficiency. *12th International Symposium on District Heating and Cooling*, Tallinn, September 5-7, 2010.

### CIII:

Karlsdottir, M. R., Lew J. B., Palsson, O. P., Palsson, H (2014): Geothermal District Heating Systems in Iceland: A Life Cycle Perspective with Focus on Primary Energy Efficiency and CO<sub>2</sub> Emission, *The 14th Int. Symp. on District Heating and Cooling*, Stockholm, September 7-9, 2014.

# Preface

This dissertation is compiled throughout roughly a decade. It has evolved around the central theme of *the primary energy factor and life cycle GHG emissions for geothermal electricity and heat production*, as these are essential energy performance indicators in both past and current EU energy policy. The early days of the research progressed from energy system modeling to life cycle assessment (LCA), as the analysis of the energy performance indicators required life-cycle thinking in their approaches. Furthermore, it became clear early in the study that a large gap existed in the literature on LCA of geothermal applications. Little or no data were available in literature or databases on life cycle inventories (LCIs) for geothermal power plants. It became evident that extensive data collection would be necessary to conduct the study.

As with most LCA studies, the process is iterative. Two “screening LCAs” were published and presented as conference papers in 2010. The first publication, conference paper **CI**, focused on the primary energy factor and life cycle CO<sub>2</sub> emissions (Global warming potential, GWP) for geothermal power production alone (Karlsdottir et al., 2010a). The second conference paper, **CII**, investigated the same factors for geothermal combined heat and power (CHP) production (Karlsdottir et al., 2010b). These two papers identified the most critical data gaps of the early LCI and initiated the collection of a detailed LCI for the drilling of geothermal wells. The complete LCI for a case study of the Hellisheidi geothermal combined heat and power plant was published in a journal paper **PI** (Karlsdottir et al., 2015) and has to date supported many publications on LCA for geothermal applications. An additional conference publication, **CIII**, focusing on an Icelandic geothermal district heating system, was also produced as a reference study to investigate the primary energy factor and CO<sub>2</sub> emissions from a stand-alone geothermal heat plant (Karlsdottir et al., 2014). Conference papers **CI-CIII** are considered additional publications that support this work, but they do not contribute directly to the dissertation's results and discussion.

The concluding publications that directly depend on **PI** and the supporting publications **CI-CIII** provide results for the LCA of the Hellisheidi geothermal CHP plant in **PII** (Karlsdottir et al., 2020b) and the implications of EU energy policy on geothermal utilization based on the LCA results in **PIII** (Karlsdottir et al., 2020a). The overall contribution of **PI-PIII** is discussed thoroughly in Section 5.1 within this dissertation. Parallel to the work of **PII-PIII**, the doctoral candidate held a position within the energy sector, working directly with geothermal applications and the specific case study used within this research. The work experience has added value and depth to the overall research in terms of more accurate modelling of the case study and a broader perspective on EU energy policy than otherwise would have been achieved.

# Table of Contents

Abstract .....	iii
Útdráttur .....	v
List of Publications.....	viii
Preface .....	ix
Terminology and abbreviations .....	xiv
List of abbreviations.....	xv
Acknowledgments.....	xvi
<b>1 Introduction .....</b>	<b>1</b>
1.1 Research question and dissertation structure .....	2
<b>2 Theoretical background .....</b>	<b>5</b>
2.1 Life cycle assessment of electricity and heat production.....	5
2.1.1 LCA of geothermal energy .....	7
2.1.2 Main environmental impacts of geothermal utilization.....	8
2.1.3 Allocation of environmental impacts from CHP plants .....	10
2.2 Energy policy .....	10
2.2.1 The primary energy factor .....	14
2.2.2 Allocation issues in EU energy policy .....	18
2.2.3 Geothermal energy within EU climate and energy policy .....	20
<b>3 Research methodology .....</b>	<b>21</b>
3.1 Life cycle assessment.....	21
3.1.1 Goal and scope .....	23
3.1.2 Inventory analysis - LCI.....	24
3.1.3 Impact analysis - LCIA .....	24
3.1.4 Interpretation – LCA and policy implications.....	25
3.2 Case study approach.....	26
<b>4 Study results.....</b>	<b>27</b>
4.1 Greenhouse gas emissions.....	27
4.2 Other environmental impacts.....	29
4.3 Primary energy efficiency .....	31
4.4 Policy implications .....	32
4.5 Overview of research structure and results.....	34
<b>5 Discussion .....</b>	<b>37</b>
5.1 Dissertation contribution .....	37
5.1.1 Life cycle assessment .....	37
5.1.2 Primary energy efficiency .....	38
5.1.3 Energy policy.....	39

5.2 Evaluation of the research .....	39
5.2.1 Reliability .....	39
5.2.2 Validity .....	41
5.3 Future research recommendations .....	43
<b>Conclusions .....</b>	<b>45</b>
<b>References .....</b>	<b>47</b>
<b>Contributing papers.....</b>	<b>55</b>
<b>Paper I.....</b>	<b>57</b>
<b>Paper II.....</b>	<b>77</b>
<b>Paper III.....</b>	<b>93</b>

# List of Figures

<b>Figure 1</b>	Overview of the research question and sub-questions and how they are addressed in the published papers of the study. ....	3
<b>Figure 2</b>	Comparison of life cycle GHG emissions from different electricity generation technologies, adopted from data presented in Annex II of the IPPC SRREN report by (Moomaw et al., 2011). Technologies are arranged according to the reported mean values in descending order. Note: The lower end of values for biopower are based on estimates of avoided emissions found in the LCA literature reviewed.....	6
<b>Figure 3</b>	The historical development of primary energy consumption in the EU-27 countries and the distance from current energy efficiency targets for 2020 and 2030 (Eurostat, 2020b). ....	13
<b>Figure 4</b>	The historical development of final energy consumption in the EU-27 countries and the distance from current energy efficiency targets for 2020 and 2030 (Eurostat, 2020b). ....	13
<b>Figure 5</b>	Example of an energy performance certificate stating the mandatory building energy rating in terms of primary energy and the optional greenhouse gas emission indicator of a residential building in Ireland (Bio Intelligence Service et al., 2013). ....	16
<b>Figure 6</b>	A geothermal CHP plant's life cycle includes different stages, from the extraction of resources to the end of life or dismantling. ....	22
<b>Figure 7</b>	The LCA according to the ISO 14000 series, with references to each published paper (adapted from (ISO 14040, 2006)).....	23
<b>Figure 8</b>	The product system used for the LCA model of a geothermal CHP plant. The system boundary shows which unit processes are included and excluded in the study. ....	24
<b>Figure 9</b>	The results for GHG emissions for electricity and heat produced from the case study according to the allocation method used.....	29
<b>Figure 10</b>	The variation of results for (a) the total PEF and (b) the non-renewable PEF according to the allocation method used. The non-renewable PEF presents the sum of all non-renewable energy inputs (non-renewable biomass, nuclear, and fossil fuels) needed to produce 1 kWh of electricity or 1 kWh of heat. ....	32
<b>Figure 11</b>	Overview of the research design and how the individual papers contribute to answering the research question.....	35

# List of Tables

**Table 1** A short review of the different allocation methods used to divide the environmental impacts of electricity and heat from CHP plants in the studies cited within this dissertation. .... 10

**Table 2** Overview of the eight legislative acts combined in the Clean Energy for all Europeans package (adopted from (European Commission, 2017))..... 14

**Table 3** Results for PEFs for different fuels according to a selection of published studies. .... 17

**Table 4** Overview of the different allocation methods suggested by the different policy documents within the “Clean energy for all” package. .... 19

# Terminology and abbreviations

**Study** refers to the research as a whole, while **dissertation** refers to the written part of the study accumulated within these pages.

**Paper** refers to published studies, such as journal or conference papers. Within this dissertation, journal papers by the author that contribute directly to main findings are denoted with a “**P**”. Conference papers by the author that serve as supporting publications to the main findings are denoted with a “**C**”.

**Primary energy factor**, **primary energy demand**, and **cumulative energy demand** are all closely related concepts and frequently used within this dissertation to describe the amount of primary energy used to supply a function. **Primary energy efficiency** is the inverse of the primary energy factor and is often used to describe a similar concept related to energy products.

**Renewables** refers to renewable energy resources or renewable energy technologies.

**Global warming potential** and **carbon footprint** are used similarly within this dissertation to refer to life-cycle greenhouse gas emissions.



# List of abbreviations

ADP	Abiotic Depletion Potential
AGM	Alternative Generation Method
AP	Acidification Potential
CED	Cumulative Energy Demand
CEN	The European Committee for Standardization (French: Comité Européen de Normalisation)
CHP	Combined Heat and Power
CML-IA	Impact Assessment method of the Centrum voor Milieuwetenschappen, Leiden University
ED	Electricity Directive
EED	Energy Efficiency Directive
EPB	Energy Performance in Buildings
EPBD	Energy Performance in Buildings Directive
EPC	Energy Performance Certificate
EU	European Union
GHG	Greenhouse Gas Emissions
GWP	Global Warming Potential
IEA	International Energy Agency
IPCC	Intergovernmental Panel on Climate Change
IRES	International Recommendations for Energy Statistics
ISO	International Organization for Standardization
LCA	Life Cycle Assessment
LCI	Life Cycle Inventory
LCIA	Life Cycle Inventory Analysis
PEF	Primary Energy Factor
PEF <sub>non-ren</sub>	Non-Renewable Primary Energy Factor
RED	Renewable Energy Directive

# Acknowledgments

Research and industry – two different worlds but at the same time interlinked and often dependant on each other. As an engineer, I strive to solve problems, come up with solutions, and see them being brought to life and put into good use. I have been so fortunate to be able to do that through my career as an engineer within the geothermal industry. But as a researcher, I have the drive to be informed, allow for critical thinking, and share findings with the scientific audience. To develop new knowledge and contribute to my field of study. Through my doctorate journey, I have received training and developed skills in doing just that. From now on, as before, I consider it my purpose to nurture the connection between geothermal research and industry - putting science into good use.

To my husband and children – Thank you for giving me the patience, support, time, and encouragement I needed.

To my family, friends, and coworkers – thank you all for always cheering me on and showing interest in my research and progress.

To my fellow Ph.D. candidates – we suffered and conquered together. You are all awesome.

To my Ph.D. committee – thank you for your everlasting support and faith that I had something to contribute. Ólafur, for everything you have done to support me, personally, professionally, and academically. You have been a true friend as well as a supervisor. Halldór, for shortening my long sentences and for endless support and fruitful discussions on thermodynamics and energy processes, our favorite topics. Jukka, for vital support on LCA methodology, new insights into scientific writing, and for creating a community of life cycle thinking at the University of Iceland with exceptional students and researchers, to whom I am also grateful.

To the University of Iceland, its staff, and the institution itself – I am honored to be a part of the UI alumni.

The research was primarily funded by the Primary Energy Efficiency (PEE) project that received funding from the Nordic Energy Research, grant number 16X753.02. Furthermore, the work was co-financed by the National Energy Fund (Orkusjóður), grant number 12-2007, and the Landsvirkjun Energy Research fund, grant number FMV 04-2013. Orkuveita Reykjavíkur (OR) supported the research by providing access to all necessary data for the case study. Furthermore, specialists at OR, Mannvit, Verkís, and Orkustofnun provided support by giving their time for professional discussions on the research topic. To all those listed above, I am forever grateful.

# 1 Introduction

The world faces an unprecedented challenge in reducing anthropogenic impacts on the environment caused by our excessive and non-sustainable natural resource consumption and pollution from human-made activities. Climate change, or “climate crisis,” as many scientists and environmentalists deem a more appropriate phrasing, is at the center of that challenge. Energy production is responsible for a large part of the global greenhouse gas (GHG) emissions that drive the climate crisis due to its heavy dependence on fossil fuels. Modern societies rely on access to energy in all aspects of people's lives; for our basic needs, health, habitats, and technology. Ensuring access to energy for all leads to increased equity and quality of life. It is one of the United Nations (UN) leading global targets for sustainable development (the 17 Sustainable Development Goals (SDGs) (United Nations, 2015). The target, called “*SDG7: Affordable and clean energy*”, sets a goal of “ensuring access to affordable, reliable, sustainable, and modern energy for all”. Our present way of producing energy is non-sustainable and drastic changes have to be made to the world's energy supply to meet this target. In summary, the replacement of fossil fuels with cleaner, more sustainable energy resources and enhanced energy efficiency to reduce energy consumption is essential to reach the goal of energy equity and stop the climate crisis at the same time.

In the current climate and energy policy of the European Union (EU), climate change and energy production are interconnected in the main targets to reduce GHG emissions under its commitments to the Paris Agreement (European Commission, 2016a, UNFCCC, 2016). In addition to cutting GHG emissions, the target is to increase the share of renewables and increase energy efficiency across the entire energy value chain. They are presented in the “2030 climate & energy framework” and supported by the “Clean energy for all” legal framework package (European Commission, 2017). At the heart of the 2030 climate & energy framework, low-emitting and efficient renewable energy technologies are strongly supported, while strict boundaries are set on technologies that do not support the framework's main targets.

The focus of this dissertation is to analyze how energy products from geothermal energy resources measure up to the EU climate and energy targets for 2030. In specific locations of the world, this energy resource plays a vital role in supplying energy to local communities, businesses, and industries. Under favorable geographical, geochemical, and economic conditions, geothermal energy is a reliable, renewable, and low-emitting source of heat and power, providing continuous base-load energy production in contrast to the varying production profiles of wind and solar energy. The dissertation furthermore focuses on high-temperature geothermal utilization for heat and power production by analyzing a selected state-of-the-art geothermal combined heat and power (CHP) plant located in Iceland.

When replacing technologies or introducing new ones, it is vital to know the possible negative and positive effects of such changes. Life cycle assessment (LCA) is a widely used methodology to analyze multiple environmental impacts of processes, products, and services holistically throughout their life cycle. LCA methodology can be used to provide valuable information on the possible environmental impacts that are not necessarily evident during the operation phase of the subject and are often hidden in the subject's production or demolition

phases. The methodology is well suited to investigate how energy technologies contribute to the climate and energy targets of the EU. Analysis of GHG emissions throughout the life cycle of energy production is either preferred or required when reporting such emissions in current GHG accounting schemes, such as the Greenhouse Gas Protocol (Hertwich and Wood, 2018). Furthermore, the LCA methodology provides the means to account for all the upstream primary energy inputs needed to extract, supply, and convert them into useful energy products such as electricity or heat. This is a preferred approach when calculating energy technologies' primary energy efficiency in the current EU energy and climate framework (European Council Directive, 2018a, ISO, 2017, European committee for standardization, 2017b).

The dissertation consists of three journal articles published in international scientific journals. Each paper investigates different aspects of geothermal energy from LCA and energy policy perspectives. The following sections in this dissertation provide the theoretical and methodological foundation of the overall study. Furthermore, this dissertation's compilation systematically reviews the three published papers to provide a complete discussion on their contribution to the overall research question that was formulated within the study. The following subsection presents the research question and how each paper contributes to an answer to the problem statement.

## **1.1 Research question and dissertation structure**

This dissertation investigates how high-temperature geothermal energy can contribute to the EU climate and energy targets for 2030. For that purpose, LCA is applied to a case study of a state-of-the-art, high-temperature geothermal combined heat and power plant located in Iceland. The dissertation's contribution is to provide both practical and theoretical contributions to the research field of high-temperature geothermal utilization in the context of energy policy and LCA methodology. There is an evident gap in the scientific literature on these subjects, particularly for high-temperature geothermal utilization, while low-temperature geothermal utilization is more extensively studied (Tomasini-Montenegro et al., 2017, Bayer et al., 2013). All in all, the study aims to holistically assess the primary energy demand and the definition of primary energy factors, GHG emissions, and other environmental impacts of high-temperature geothermal utilization and connect the results to the main targets of current EU energy policy. The overall research question (RQ) of the dissertation is defined as:

***“Should geothermal energy be a part of our future energy systems to battle climate change and our non-sustainable use of resources?”***

Since the RQ is extensive, four sub-questions (**SQ1-SQ4**) were derived by narrowing down the dissertation's focus on the particular aspects of geothermal energy and current energy policy. These are:

**SQ1:** *How does high-temperature geothermal utilization contribute to lowering GHG emissions from the energy sector?*

**SQ2:** *Are there any adverse environmental impacts other than GHG emissions that affect high-temperature geothermal utilization potential to be a part of future energy systems?*

***SQ3:** How does the primary energy efficiency concept relate to geothermal energy technologies, and how substantial is the share of non-renewable energy demand during the life-cycle of such technologies?*

***SQ4:** How does high-temperature geothermal energy technology compare to the current EU climate and energy policy?*

Since the characteristics of geothermal energy resources are very different from site to site, the study’s intention is not to answer the research question for all types of geothermal energy technologies but to focus explicitly on utilizing high-temperature geothermal resources for electricity and heat production in a power plant near Reykjavik in Iceland. Geothermal energy is abundant in Iceland, and its utilization is one of the main sources of primary energy to sustain the country’s energy demand. Another reason is that studies on life cycle environmental impacts of low-temperature utilization have had a broader representation in both research and policymaking, while the gap in the literature is evident for high-temperature geothermal energy.

Each of the published papers contributes significantly to the overall research question while addressing different aspects. Figure 1 shows how individual papers address the different sub-questions of the dissertation.

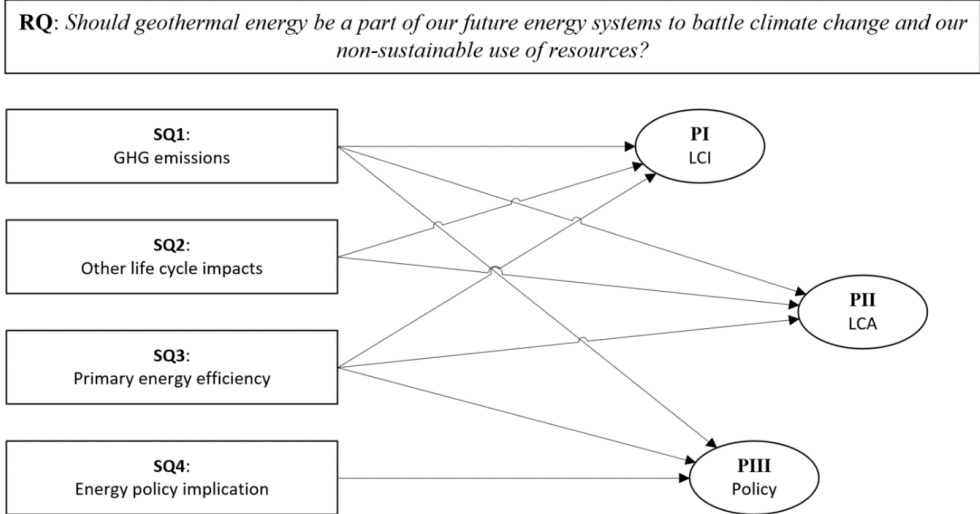

**Figure 1** Overview of the research question and sub-questions and how they are addressed in the published papers of the study.

The dissertation is organized as follows: Section 2 presents the thesis's theoretical context, describing the link between LCA studies and the EU climate and energy policy. Section 3 covers the methodology. Section 4 reviews the main results and describes how the different published papers contribute to the overall results of the dissertation. Section 5 discusses the results further and relates the contribution to the different topics investigated. It furthermore evaluates the validity and reliability of the study and recommends future research. Short concluding remarks are given in Section 6, followed by the references and a copy of the published papers I-III (PI-III).



## **2 Theoretical background**

This section covers the relevant literature that served as a foundation for the study. The main theory evolves around LCA studies of geothermal energy systems producing electricity or heat. Reviewing LCA studies of other energy technologies also serves as an essential part of the study for comparison purposes. Furthermore, a particular focus is set on CHP plants to review the different methods used to allocate environmental impacts between heat and electricity in such joint production processes. Lastly, publications on EU energy policy, such as official documents from government bodies and scientific literature or reports, set the background for the study's energy policy aspect.

### **2.1 Life cycle assessment of electricity and heat production**

Energy is a necessity in almost every aspect of our lives, from producing goods, offering services, and running day-to-day operations of homes, businesses, and industries. Therefore, energy inputs are needed in the vast majority of LCA studies of products, services, and processes (Curran et al., 2005). To correctly represent the intrinsic environmental impacts associated with the energy use in LCAs, quality life-cycle inventory data (LCI) for different energy production systems have to be accessible in databases or literature.

Energy systems are a popular field within LCA research and application, especially electricity generation technologies. A vast number of publications and review studies are available for different electricity technologies. Turconi et al. (2013) published a highly cited review study for a wide range of renewable and non-renewable technologies. They conclude that the most significant environmental impacts for fossil-fueled power plants result from direct emissions within these plants' operational phases. At the same time, energy resource acquisition was the most critical source of impact for nuclear and biomass technologies. Lastly, the construction of infrastructure was responsible for the majority of environmental impacts from renewables.

LCA studies often focus on assessing GHG emissions over the life-cycle of electricity technologies. A special report by the IPCC on renewable energy sources and climate change mitigation (SRREN) publishes a range of LCA GHG emissions from a review of LCA studies on different electricity technologies. The results from the SREEN report are presented in Figure 2 (Moomaw et al., 2011). They show how the fossil-fueled technologies are grouped at the high-end of GHG emissions per kWh produced, while renewable technologies are grouped at the lower end of emissions per kWh. Since LCA assesses the entire life-cycle, emissions from renewable sources are made visible through the environmental impacts associated with the resource acquisition and infrastructure (or manufacturing) life cycle stages.

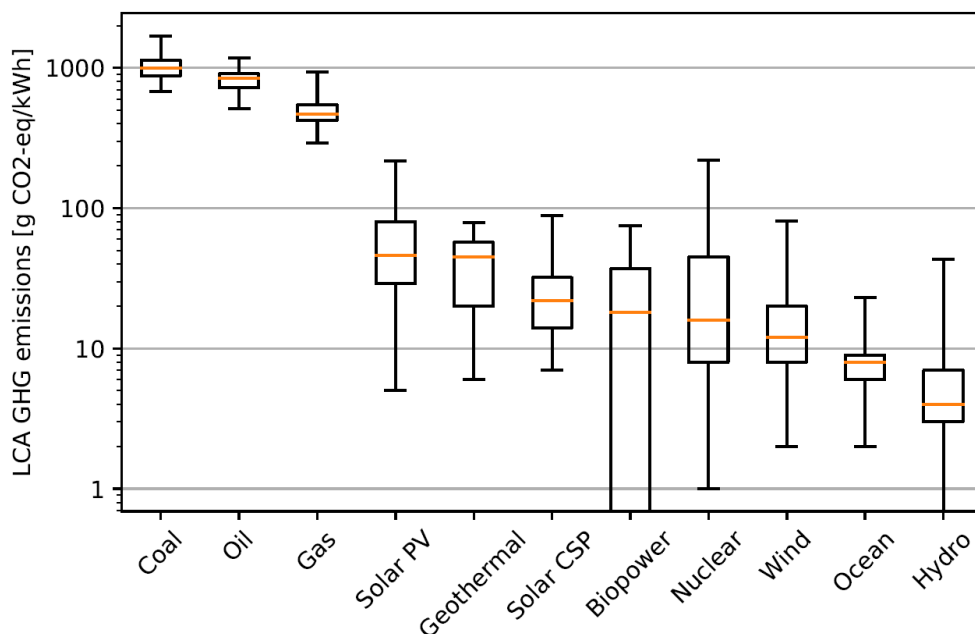

**Figure 2** Comparison of life cycle GHG emissions from different electricity generation technologies, adopted from data presented in Annex II of the IPCC SRREN report by (Moomaw et al., 2011). Technologies are arranged according to the reported mean values in descending order. Note: The lower end of values for biopower are based on estimates of avoided emissions found in the LCA literature reviewed.

LCA studies comparing energy technologies providing heat for buildings are not as readily available and comprehensive as electricity generation studies. Many different technologies are available to supply heat to buildings, such as district heating (DH) services with a centralized heating production that serves multiple buildings (e.g., from combined heat and power (CHP) production), or individual heating systems installed for the individual buildings (e.g., gas or biomass furnaces, heat pumps e.t.c.). These technologies depend on different energy resources and infrastructure needed to construct the energy system. A detailed LCA on different life cycle stages of a DH system was carried out by Fröling et al. (Fröling et al., 2004, Fröling and Svanström, 2005, Persson et al., 2006) showing that the use phase of such systems, stemming from the production of the heat delivered, is responsible for over half of total environmental impact. Thus, the energy resource used to produce heat is of essential importance. Most CHP plants and other heat providers for district heating systems use energy resources of fossil origin or require biomass burning (Werner, 2017).

The complexity and wide variety of heating services available make it difficult to systematically review and compare all the different heat production methods in terms of their life cycle performance. The studies published usually focus on a limited selection of technologies to compare. For example, a study by Neirotti, Noussan, and Simonetti (2020) investigated the difference in life cycle environmental impacts between heat delivered by an existing DH network in Turin, Italy, and a traditional gas boiler. The results depended heavily on the allocation method used to divide environmental impacts between heat and electricity. When the allocation of GHG emissions put low burdens on heat from a CHP plant, district



heat performed better than the individual gas boiler while being worse for some other means of allocation. Another study concludes that an individual air source heat pump performs better than a DH network in Hangzhou, China (Zheng et al., 2016). Heinonen et al. (2015) also compare heat pumps to district heat from CHP plants by showing how different analysis assumptions affect the outcome, switching the results on which system would be preferable to cover heat demand based on life cycle GHG emissions. The assumptions investigated were the allocation method used for the CHP plant, the choice of the source of electricity, and the emission intensities of the different energy technologies. The environmental performance of different heating solutions will thus be dependent on local or national conditions or assumptions made in the studies, such as the primary source of electricity, the availability of heat from CHP production, the primary source of fuel for individual heating, and the allocation method selected.

### **2.1.1 LCA of geothermal energy**

It is typical to classify geothermal energy resources into high-temperature and low-temperature resources. High-temperature resources are of volcanic origin and generally produce geothermal fluid at temperatures above 150°C at 1 km depth below the surface. Low-temperature resources draw heat from the natural heat flow of the earth's crust and are available at lower temperatures than 150°C at 1 km depth (Saemundsson et al., 2009). Typically, high-temperature resources are used to produce electricity. In contrast, low-temperature resources are more suitable for direct utilization, e.g., for heating purposes, swimming and bathing, and heating greenhouses. However, low-temperature resources can be used for electricity generation using binary cycle technology if the produced geothermal fluid temperature is high enough (DiPippo, 2008). Subsequently, high-temperature utilization often produces valuable effluent heat that can be used for the same purposes as low-temperature resources.

The dissertation focuses on the use of high-temperature geothermal energy for the production of electricity and heat. High-temperature geothermal resources are available at various locations worldwide, and these are used most extensively for electricity production in the United States, Indonesia, Philippines, Turkey, and Kenya (Huttrer, 2020), to name a few. European countries that use high-temperature geothermal resources for energy production are Italy and Iceland. The availability of LCA studies on geothermal energy technologies is scarce (Bayer et al., 2013; Tomasini-Montenegro et al., 2017). One of the main conclusions of such studies is the low generalizability of case studies' results due to the wide variety of characteristics, such as emissions, from the different geothermal applications.

Previous studies that published LCA results for geothermal power generation have mainly focused on low- to medium-temperature utilization using binary cycle technologies for power production. In a recent review by Tomasini-Montenegro et al. (2017), LCA studies on energy production from geothermal sources were presented. They specifically mention the scarcity of LCA studies focusing on flashing (high-temperature) technologies in the geothermal sector, although these technologies are responsible for 63% of the world's installed geothermal power capacity (Bertani, 2015). A former review by Bayer et al. (2013) also pointed out the scarcity of LCA studies for geothermal energy production in general. Between the publication of those two review studies, numerous scientific publications regarding LCA and geothermal utilization have been made, making it evident that the LCA methodology is gaining interest within the geothermal sector.

Among the newest published studies, Hanbury and Vasquez (2018) apply a stochastic approach in their LCA study to allow variations in the life cycle inputs to a modern geothermal binary power plant located in northern Nevada, USA. They find that most environmental impacts are associated with using fossil fuels for drilling and transportation in the plant's construction phase since practically no direct emissions stem from the binary power plant in question during operation. This is, however, not true for high-temperature geothermal power plants using flash or dry steam technology. Buonocore et al. (2015) performed LCA on a 20 MW dry steam power plant in Tuscany, Italy. The study used the CML 2001 and Cumulative Energy Demand (CED) methods to perform the life cycle impact assessment (LCIA). It reports GWP of 248 g CO<sub>2</sub> eq/kWh and total CED of 25.6 MJ/kWh (7.1 kWh/kWh) and non-renewable CED of 0.8 MJ/kWh (0.2 kWh/kWh) with more than 99% of the CED referring to the input of geothermal energy in the operational phase of the power plant. They also report the contribution of decommissioning and disposal of power plants and find them to be neglectable. Parisi et al. (2019) publish a comprehensive LCA-based study on multiple geothermal power plants in Tuscany, Italy, focusing on atmospheric emissions of various gases. They show large variations in environmental impacts from the different plants and how mitigation methods can have considerable effects in reducing geothermal utilization's environmental impacts.

Similar findings on the difference between the contribution of different life cycle phases to the overall GHG emissions from geothermal binary plants and high-temperature flash plants are reported in a systematic review on published life cycle GHG emissions from geothermal electricity generation, made by the US Department of Energy National Renewable Energy Laboratory (NREL), (Eberle et al., 2017). The report further highlights that studies on flash technologies (Hondo, 2005, Sullivan and Wang, 2013, Martinez-Corona et al., 2017, Karlsdottir et al., 2010a, Skone et al., 2012, Sullivan et al., 2014, Marchand et al., 2015) generally produce higher GHG emissions per kWh than binary technologies due to the release of non-condensable gases during operation of flash plants while binary plants operate in a closed-loop system.

Geothermal energy is particularly suited for combined heat and power (CHP) production in locations with access to geothermal resources in close vicinity to heat demand. Geothermal CHP plants can be found in various locations around the world, including Austria, Germany, Iceland, the USA, and Thailand (Lund and Chiasson, 2007, DeLovato et al., 2019). Very few published geothermal LCAs focus on geothermal CHP plants. One example is a study by Frick et al. (2010), who analyzed a geothermal binary CHP plant. They conclude that such plants can lower GHG emissions and other environmental impacts compared to the current energy mix of electricity and heat. Furthermore, they report on the importance of favorable geological conditions when utilizing geothermal energy, as in some cases, the environmental impacts were similar to fossil-fuelled energy production.

### **2.1.2 Main environmental impacts of geothermal utilization**

The main environmental impacts are commonly listed as; gaseous emissions of geothermal origin, thermal pollution to the atmosphere from cooling towers and to the surface due to hot geothermal effluent from energy facilities, chemical pollution due to dissolved minerals, and trace chemicals in geothermal effluent, as well as land deformation and increased seismicity due to the extraction (and reinjection) of fluid from reservoirs (Kristmannsdóttir and Ármannsson, 2003, Rybach, 2003). The method of LCA, as used in this study, only captures a portion of those potential impacts. Examples of environmental impacts of geothermal energy

that are typically not covered by LCA methodology are; the effects of the reinjection of geothermal fluid on induced seismicity (Juncu et al., 2018), and loss of biological diversity due to habitat destruction or effects of the release of geothermal fluid or gasses on specific species (Mutia et al., 2016). These impacts are well known in geothermal utilization and are commonly addressed in environmental impact assessments (EIA) prior to constructing geothermal projects. Mitigation methods are also available for minimizing those impacts.

As shown by the review in Figure 2, geothermal utilization can result in low CO<sub>2</sub> equivalent emissions over its life cycle and be compatible with other renewable energy resources. However, rare cases exist where CO<sub>2</sub> emissions from geothermal plants exceed even those of coal power plants, such as examples in Turkey have shown due to reservoir characteristics of carbonate-rich rock formations (Niyazi et al., 2015). In Italy, relatively high CO<sub>2</sub> emissions per kWh produced are also reported (Manzella et al., 2018, Bravi and Basosi, 2014, Parisi et al., 2019). A debate is ongoing whether or not to account for CO<sub>2</sub> emissions from geothermal plants due to the occurrence of a natural flux of CO<sub>2</sub> from geothermal fields. As an example, Bertani and Thain (2002) conclude that there is evidence of a decrease in natural flux from geothermal areas in Italy once geothermal plants started their operations, even to the degree that balances out the plant's direct emissions. Other studies have shown the opposite: that the natural flux of CO<sub>2</sub> has increased after commissioning a geothermal plant, e.g., in Reykjanes, Iceland (Óladóttir and Friðriksson, 2015). As a result of these conflicting results, Italy does not include GHG emissions from geothermal power plants in its national inventory report on anthropogenic emissions (Ármannsson et al., 2005), while Iceland includes these emissions in its reports (Iceland Environmental Agency, 2020). To date, the balance between the natural flux of CO<sub>2</sub> and direct emissions from geothermal plants has not been fully understood, and further research is needed to determine this relationship and the site-specific nature of the phenomenon (Friðriksson et al., 2017). In the LCA studies reviewed in Section 2.1.1, direct emissions from geothermal plants are fully accounted for in all of the assessments.

H<sub>2</sub>S emissions are of particular importance when analyzing the environmental impacts of geothermal utilization and are among the main recognized environmental issues. In Iceland, where utilization of geothermal energy is extensive, local communities publicly debated the concentration of H<sub>2</sub>S in the vicinity of the case studied within this dissertation due to odor nuisance after the plant started operation in 2006 (Gunnarsson et al., 2013) and due to unknown health effects of H<sub>2</sub>S in continuous and low concentration (Finnbjornsdottir et al., 2016, Finnbjornsdottir et al., 2015). In current LCA impact assessment (LCIA) methods, the environmental effects of H<sub>2</sub>S are inadequately represented due to the immaturity of research in general on the effects of H<sub>2</sub>S emissions. In fact, research on the impacts of such inorganic chemicals in the field of life cycle impact assessment is a very relevant topic in LCA (e.g., (Kirchhübel and Fantke, 2019)).

Nonetheless, LCA is considered the most potent, consistent, and holistic tool available to assess a selection of environmental impacts by including different life cycle stages and the most relevant parts of the value chain of products and services (Curran, 2014). The use of LCA methodology achieves two things: First, providing an academically accepted methodology that follows international standards allows for a comprehensive comparison of different technologies. Second, it highlights multiple categories of environmental impacts instead of focusing on a single impact at a time, making it possible to see rather robustly if a specific technology that performs well in a specific impact category has adverse effects in other impact categories.

### 2.1.3 Allocation of environmental impacts from CHP plants

The allocation of impacts between multiple products from a single production system is a widely discussed topic in LCA research. A conclusion on appropriate allocation methods for different systems is yet to be achieved. Different studies use a wide variety of available methods, even within the same field of study (Cherubini and Strømman, 2011). The allocation method chosen is of extreme importance, as it decides which product from a multifunctional production process bears the heaviest burden (e.g. (Soimakallio et al., 2011)).

Discussion of correct, fair, or preferred allocation methods for CHP plants is both ongoing and somewhat non-conclusive within the CHP industry, energy policy, and statistics. The method chosen for allocation will significantly affect the outcome of the two key indicators for GHG emissions and primary energy for the electricity and heat outputs of those plants, as discussed shortly in the subsection above. A short review of different allocation methods used in the studies cited within the dissertation is given in Table 1.

**Table 1** A short review of the different allocation methods used to divide the environmental impacts of electricity and heat from CHP plants in the studies cited within this dissertation.

Publication	Allocation method			
	<i>Energy</i>	<i>Exergy</i>	<i>Economic</i>	<i>AGM*</i>
Frick et al. (2010)		X		
Heinonen et al. (2015)	X			X
Holmberg et al. (2012)	X	X	X	
Moretti et al. (2020)		X	X	
Neirotti et al. (2020)	X	X		
Zheng et al. (2016)	X			

\* AGM = Alternative Generation Method, also called the “Finnish” or “Benefit” method.

## 2.2 Energy policy

EU energy policy is one of the main foundations of this research. The need to measure high-temperature geothermal energy utilization against the relevant climate and efficiency targets for future energy systems was evident due to the lack of research and general discussion on the topic. Geothermal energy resources, especially those of high-temperature origin, are not utilized extensively within the EU, as evidenced by the lack of representation of geothermal issues in EU energy and climate policy documents. Thus, hardly any publications were available on the subject.

Most of the current text on EU energy policy is found in government or legislative documents published by the EU. The drawbacks of connecting research results to current policy are that policies are subject to frequent changes, such as is the case with the EU energy policy. Below,

the recent development of EU climate and energy policy's main targets is described along with the relevant literature and connection to global targets on GHG emission reduction. The section thus describes the state of the policy used in the dissertation to evaluate geothermal energy's role against policy targets.

In 2015, the 21<sup>st</sup> UN Conference of the Parties (COP21) was held in Paris to create the “Paris Agreement”, a joint and global commitment to lower GHG emissions according to scientifically calculated pathways to keep the global average temperature rise well below 2°C compared to pre-industrial levels, and preferably below 1.5°C (UNFCCC, 2016). The participating nations in the Paris Agreement are obliged to put forward “nationally determined contributions (NDCs)” where they regularly report on progress made and the set goals (United Nations, n.d.). The member states of the European Union (EU), in cooperation with the non-EU states Iceland and Norway, are Parties to the Paris Agreement and have put forward a combined commitment on GHG emission reduction of at least 40% compared to 1990 levels. The emission reduction target is revised regularly and is currently expected to be revised upwards in 2021.

The EU has linked the NDCs of the Paris Agreement to the current “2030 climate and energy framework” climate and energy-related targets (European Commission, 2016b). For the last decade or so, the EU has shown a noticeable ambition to put forward a clear and forward-thinking climate and energy goals and supporting legislative acts. The EU first adopted a package of energy and climate measures in 2008, setting the 20/20/20 targets. These targets are aimed at decreasing GHG emissions by 20% (from 1990 levels), increase energy efficiency by 20% (compared to “business as usual” scenario projections for 2020 energy use made in 2007), and achieving a 20% share of renewables within the EU. Already in 2012, reports showed the EU was well on its way to meeting the 20/20/20 targets. The European Commission, therefore, requested the construction of the next climate and energy framework to set ambitious key targets for the period 2021-2030 (European Commission, 2014). In 2015, the new 2030 climate and energy framework, “Clean energy for all Europeans”, was adopted with updated targets from the 2020 package. Furthermore, the targets for energy efficiency and share of renewables were revised upwards in 2018 and have been in a second revision process in the year 2020. The following key targets are now officially adopted (European Commission, 2016a, European Commission, 2017, Directorate-General for Energy, 2019):

- No less than a **40% reduction of greenhouse gas emissions** compared to 1990 levels (to be revised upwards to 55% in 2021). The target is twofold, where sectors under the EU emissions trading system (ETS) must cut emissions by 43%, and non-ETS sectors (emissions under each Member State) need to reduce emissions by 30%, both compared to 2005 levels (European Commission, 2016a).
- No less than a **32% share of renewable energy** in final energy use (revised upwards in 2018 from a target of 27%) (European Commission, 2016a, European Commission, 2017).
- No less than a **32.5% improvement in energy efficiency** compared to projections from 2007 (revised upwards in 2018 from a target of 27%, with possible revision in 2023) (European Commission, 2016a, European Commission, 2017).

The first target addresses the overall GHG emissions across all sectors and regions within the EU. The largest share of total GHG emissions within the EU originates from the burning of

fossil fuels (European Commission, 2020a). Therefore, shifting towards more sustainable and low emitting energy resources plays a significant part in the EU reaching its climate target.

The second target addresses renewables' role in reaching a more sustainable use of energy and lowering GHG emissions related to energy use, therefore supporting the first target. Current available renewable energy technologies include hydropower, wind, solar (photovoltaic and thermal), geothermal, marine energy (wave and tidal), and bioenergy (biofuels, biogas, biomass, and waste) (IRENA, 2020, Ritchie, 2017). Hydropower is the largest renewable energy source by far as of 2019 world statistics, while wind and solar have been increasing their share in the energy mix rapidly in recent years (Ritchie, 2017). Furthermore, the share of bioenergy has been rapidly increasing in the EU (Eurostat, 2020a). While marine energy technology is still not matured, and the costs are high, it has vast potential when technological, economic, and ecological barriers have been overcome (Islam and Hasanuzzaman, 2020). Geothermal energy utilization is a mature technology but accounts for less than 0.5% of the world's electricity demand. However, geothermal is considered to have vast potential to produce electricity and thermal energy worldwide (Huttrer, 2020, Lund and Toth, 2020). All of these renewable energy technologies have the potential to increase the share of renewables in Europe by different means and magnitudes.

The third target in the EU's climate and energy policy focuses on energy efficiency. It is intended to reduce GHG emissions from energy use as a means to support the first target and to push forward the sustainable and responsible use of energy resources. The targets are set in terms of both primary energy consumption and final energy consumption. Primary energy defines the original resource's energy content (fossil, hydro, solar, wind, geothermal, etc.) from which energy products (e.g., heat and electricity) are made. Final energy consumption is the energy consumed by the end-users. Conversion of final energy consumption to primary energy consumption can be made by applying the primary energy efficiency of the different energy technologies, by using a factor called the "primary energy equivalent" (IEA, 2017) or "primary energy factor" (PEF) as defined in EU energy policy (European council directive, 2018b). The progress made and the gap towards EU energy efficiency targets for 2020 and 2030 are shown in Figure 3 and Figure 4 (Eurostat, 2020a).

### Distance to 2020 and 2030 targets for final energy consumption, EU-27



Source: Eurostat (online data code: nrg\_ind\_eff)

eurostat

**Figure 3** The historical development of primary energy consumption in the EU-27 countries and the distance from current energy efficiency targets for 2020 and 2030 (Eurostat, 2020b).

### Distance to 2020 and 2030 targets for primary energy consumption, EU-27

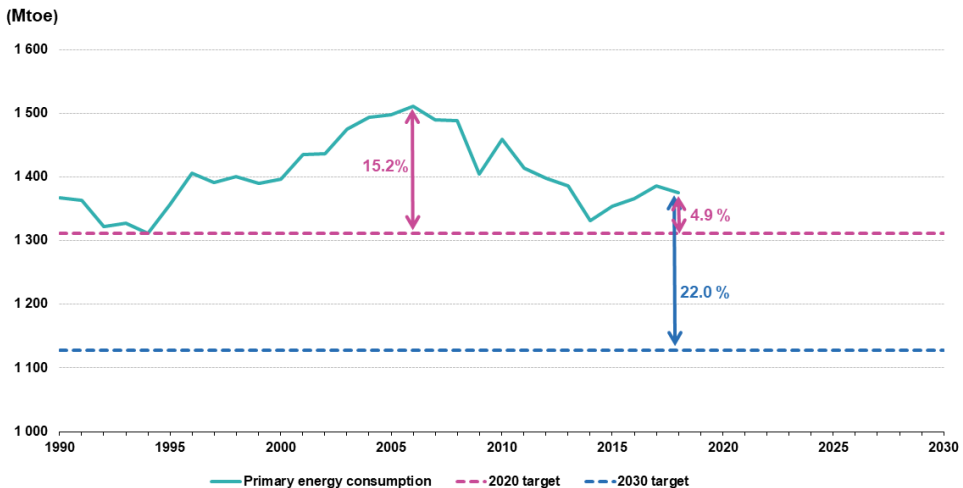

Source: Eurostat (online data code: nrg\_ind\_eff)

eurostat

**Figure 4** The historical development of final energy consumption in the EU-27 countries and the distance from current energy efficiency targets for 2020 and 2030 (Eurostat, 2020b).

The 2030 climate and energy framework is reinforced with the “Clean Energy for all Europeans Package” that includes eight revised legislative acts to support those key targets. An overview of those legal acts is given in Table 2 (European Commission, 2017). Additionally, as a long-term strategy, the EU aims to be “climate-neutral” by 2050, as put forward in “The European Green deal” growth strategy for the EU, presented in December 2019 (European Commission, 2019).

**Table 2** Overview of the eight legislative acts combined in the Clean Energy for all Europeans package (adopted from (European Commission, 2017)).

<b>Legislative act</b>	<b>Official Journal Publication (date and official document)</b>
Energy Performance in Buildings Directive (EPBD)	19/06/2018 - Directive 2018/844
Renewable Energy Directive (RED)	21/12/2018 - Directive 2018/2001
Energy Efficiency Directive (EED)	21/12/2018 - Directive 2018/2002
Governance of the Energy Union	21/12/2018 - Regulation 2018/1999
Electricity Regulation	14/06/2019 - Regulation 2019/943
Electricity Directive (ED)	14/06/2019 - Directive 2019/944
Risk Preparedness	14/06/2019 - Regulation 2019/941
Agency for the Cooperation of Energy Regulators (ACER)	14/06/2019 - Regulation 2019/942

There are two important energy performance indicators for energy technologies within the EU climate and energy policy. Those are the Greenhouse Gas (GHG) Emission Factor and the Primary Energy Factor (PEF). Those two factors provide essential information needed to evaluate different technologies' energy performance in context with the EU targets. The GHG emission factor corresponds to GWP results from LCA studies and is often readily available in the literature for all the different energy technologies. The relevant literature covering the GHG emission factor includes the same publications as discussed for LCA studies on energy systems in Section 2.1.1. The PEF, however, is a less studied factor and with less consistency in calculation than the GHG factor. The following subsection will review the relevant theoretical foundation of PEFs in the current literature.

### **2.2.1 The primary energy factor**

The concept of primary energy is generally used to define the energy content of the primary energy resource (fossil, hydro, solar, wind, geothermal, etc.) from which usable energy is produced (electricity, heat, fuels for transportation, etc.). It is widely used to describe the physical flow of energy in energy systems, comparison of national energy uses in statistical reports, and recently also as a key indicator in energy policy (Hitchin, 2018). Primary energy factors (PEFs) describe how efficiently a flow of primary energy from an energy resource is converted into usable energy products.

A simplified general equation for calculating the PEF for energy products according to the Eurostat definition (Eurostat, 2019) is given in Equation (1);



$$\text{PEF}_{\text{energy system}} = \frac{\text{Primary energy input from resources}}{\text{Usable energy output}} = \begin{cases} 1 & \text{(for most renewables)} \\ 1/\eta & \end{cases} \quad (1)$$

where  $\eta$  is the 1st law (thermal) efficiency of the energy conversion process. As can be seen from Equation (1), the PEF for most renewable sources becomes 1 (corresponding to 100% efficiency) due to the definition by the IEA of the primary energy content of most renewable energy resources (IEA, 2017). For other energy resources, the PEF is a function of the particular energy technology's thermal efficiency  $\eta$ .

The PEF is a fundamental indicator for calculating the primary energy use, either of a single building or in a broader perspective (e.g., on a regional level) in EU energy policy. The Energy Efficiency Directive (EED) relies on PEFs to account for the savings and annual reduction of primary energy use of Member States towards the target of increased energy efficiency (also closely related to the decrease of greenhouse gas emissions target) within the Union (European council directive, 2018b). It is also fundamental for the EPBD to calculate the energy performance of buildings, where it serves as a basis for the mandatory energy performance indicator stating the primary energy use of a building in kWh/m<sup>2</sup>/year, as seen in the example of an energy performance certificate (EPC) (European Council Directive, 2018a) in Figure 5.

The previous CEN standard that supported the EPBD directive from 2010 (European council directive, 2010/31/EU) defined a calculation methodology of PEFs (EN 15603:2008, 2008) and published a set of factors for various energy technologies and fuels. No such set of factors has yet been published for the newly amended EPBD directive (European Council Directive, 2018a) and the supporting standards (ISO, 2017, European committee for standardization, 2017b).

A review of published factors from the most comprehensive publications on PEFs, and a comparison to the values calculated for geothermal within this dissertation, is shown in Table 3. The first four sets of factors (M1-M4) are retrieved from a report made for the European Commission on the different approaches of calculating the primary energy factor for energy technologies (Fraunhofer-Institut für System- und Innovationsforschung (ISI), 2016). The report is one of the most comprehensive publications available on PEF calculation methodology. It highlights the high level of complexity of such calculations and publishes results for individual energy technologies and the EU PEF based on four different methods. Another comprehensive publication on PEFs for different energy technologies is by IINAS (IINAS, 2015), based on LCA methodology and the GEMIS (global emission model for integrated systems) database (IINAS, 2014). The third set of published factors reviewed here is the previously mentioned set from EN 15603:2008 (2008).

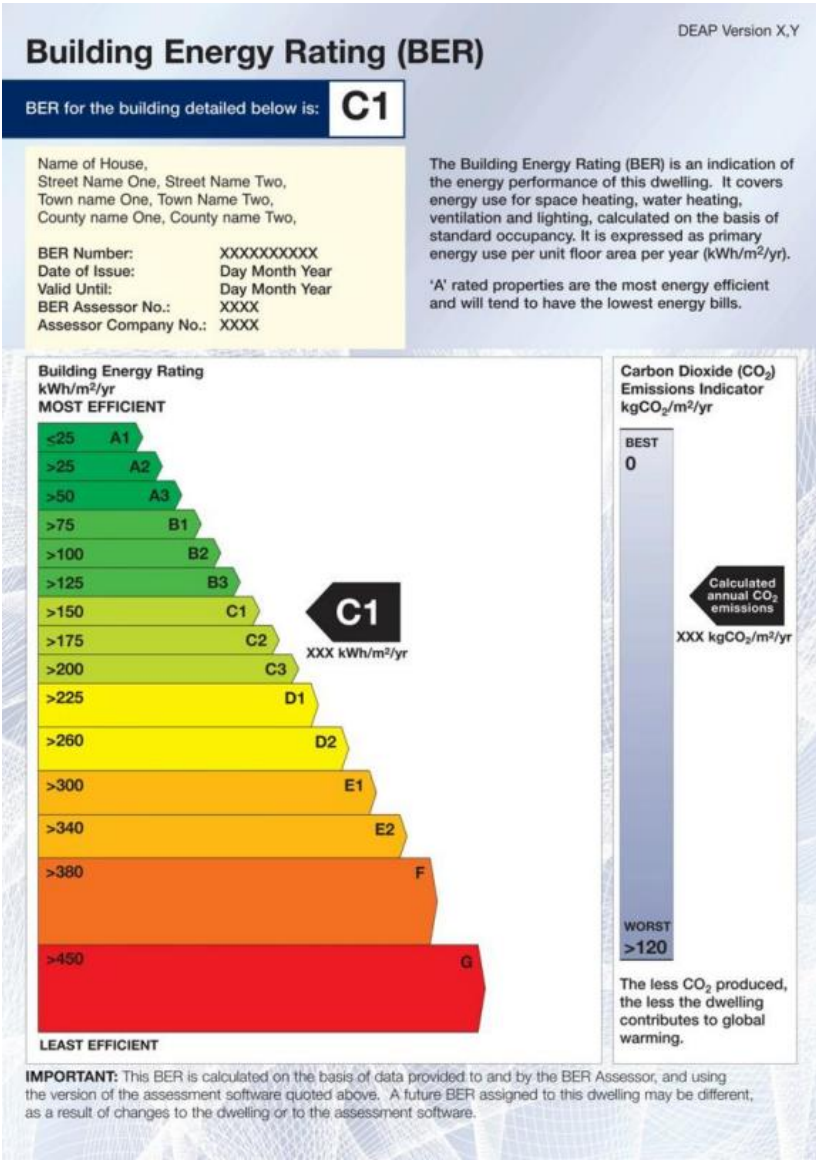

**Figure 5** Example of an energy performance certificate stating the mandatory building energy rating in terms of primary energy and the optional greenhouse gas emission indicator of a residential building in Ireland (Bio Intelligence Service et al., 2013).

**Table 3** Results for PEFs for different fuels according to a selection of published studies.

Source	Nuclear	Solar	Wind	Hydro	Geo-thermal	Fossil	Biomass and waste	EU mix	Calculation method
M1 <sup>(1)</sup>	3.03	1.00	1.00	1.00	10.00	2.28	3.53	1.87	Non-LCA, physical energy content, IEA allocation CHP, 2020 EU PEF
M2 <sup>(1)</sup>	3.03	0.08	0.03	0.06	1.00	2.51	0.53	1.59	LCA, non-ren PEF, Finish allocation CHP, 2020 EU PEF
M3 <sup>(1)</sup>	3.03	1.00	1.00	1.00	10.00	2.28	3.53	2.01	Non-LCA, direct equivalent, Finish allocation CHP, 2020 EU PEF
M4 <sup>(1)</sup>	3.03	1.00	1.00	1.00	10.00	2.51	3.53	2.09	LCA for non-ren, Finish allocation CHP, 2020 EU PEF
IINAS 2015 <sup>(2)</sup>	3.15-4.05	1.25	1.03	1.01	1.02	2.47	2.47	2.67	2013 EU PEF LCA and direct equivalent for all REN
ISO 15603 <sup>(3)</sup>	2.80	n.a.	n.a.	1.10	n.a.	4.05	n.a.	3.14	No reference data given for calculation methods

<sup>(1)</sup> Fraunhofer-Institut für System- und Innovationsforschung (ISI) (2016)<sup>(2)</sup> IINAS (2015)<sup>(3)</sup> EN 15603:2008 (2008)

Table 3 shows how the PEF for geothermal is an outlier in most cases compared to the other energy technologies due to its comparatively high value. The methods that follow the definition of the primary energy content of geothermal fluid as suggested by the IEA and Eurostat (IEA, 2017, Eurostat, 2019) show PEF values between 5.2-10.0, while method M2 from the ISI report and the IINAS method show considerably lower values of 1.00-1.02 respectively. These two results stand out due to different reasons. The former mentioned, M2 (Fraunhofer-Institut für System- und Innovationsforschung (ISI), 2016), only includes the flow of non-renewable energy inputs to the conversion process. Since geothermal energy is a renewable energy resource, the flow of geothermal energy through the process is not accounted for, leading to a relatively low PEF. The latter mentioned, the IINAS method (IINAS, 2015), accounts for all primary energy flows, both non-renewable and renewable, but uses the same definition of primary energy content for geothermal energy as is generally used for the other renewable resources, namely the “direct equivalent” method. The direct equivalent method sets the primary energy input to an energy conversion cycle equal to the energy output in the form of electricity, translating into 100% conversion efficiency between the primary energy source and the final energy product. According to international energy bodies, this method is the default method to describe all renewable sources' primary energy content, except for geothermal resources and solar-thermal technologies that shall use the physical energy content that takes the actual generation efficiency into account.

Another interesting finding from Table 3 is how the lack of consistency in calculation methods for PEFs can lead to different results for some energy sources. As an example, the PEFs for geothermal range from 1.00 to 10.00. Other PEFs show more consistent values between the different publications and methods. An exception is the PEF values calculated with method M2 that only includes the non-renewable energy inputs and excludes all renewable energy inputs from the PEF, leading to much smaller PEF values for energy technologies of renewable origin. This shows that the use of a standardized calculation methodology proposed by the older EPBD standard on how to calculate PEFs (EN 15603:2008, 2008) did not reach the intended audience, and it is important to communicate the importance for future PEF calculations to follow the new set of standards (ISO, 2017, European committee for standardization, 2017b) to ensure consistency between PEFs.

This study sets out to highlight these inconsistencies in the calculation of PEFs for different energy resources and technologies.

### **2.2.2 Allocation issues in EU energy policy**

Allocation of environmental impacts between different energy products is also a complicated issue within energy policy, just as within LCA studies as discussed in Subsection 2.1.3. The three main EU directives supporting the key energy and climate targets, the RED, EED, and EPBD, include, or refer to, a discussion on allocation factors for CHP production related to the calculation of GHG emissions or the PEF.

The RED discusses the allocation of GHG emissions from CHP production and recommends using the energy allocation method. However, the RED only discusses the allocation of emissions in connection with the use of biomass fuels and bioliquids for CHP production (European council directive, 2018c). The RED thus seems to omit the possibility of utilizing geothermal energy for CHP production. Nevertheless, it can be assumed that the RED would recommend the use of energy allocation across all renewable energy sources used to produce CHP.

The EED focuses on primary- and end energy use and supports the energy efficiency target. The PEF is, therefore, a key indicator in context to the EED to account for the primary energy use. The EED shortly addresses the need for allocation of primary energy share to electricity from CHP plants and refers directly to Annex II within the directive for the methodology to be applied (European council directive, 2018b). The method given in the Annex is based on comparing the CHP actual production efficiencies to efficiency reference values for separate production processes of electricity and heat. Although the method is not given a title in the Annex, it is fully compatible with the so-called „Finnish method“, also called the Alternative Generation Method (AGM) (EPD International, 2020).

The EPBD relies strongly on PEFs as they are essential to calculate the required primary energy use of a building, so allocation of primary energy in CHP production is an issue in the EPBD. The directive itself does not address the allocation issues connected to the energy supplied to a building from CHP production but refers to the calculation methodology of the ISO 52000 standard series (European Council Directive, 2018a). The ISO standards that address allocation issues for CHP production are ISO 5200-1:2017 and 5100-02:2017 (ISO, 2017, European committee for standardization, 2017b), with the addition of the European standard EN 15316-4-5:2017 (European committee for standardization, 2017a). The EN 15316 has the most elaborate discussion on allocation methods to be used for co-produced electricity and heat and lists the following methods: The Carnot method (comparable with the commonly used exergy method in LCA allocation procedures), Alternative production method (compatible with the AGM mentioned above), Residual heat method, and the Power loss ref method. These methods are all showcased for the allocation of the primary energy and it is not specified in the standards if they should also be used for the allocation of GHG emissions.

It is evident from the above discussion that there is a lack of consistency in the energy and climate policy framework between recommendations or requirements of allocation methodology for calculating the GHG emission factor and the PEF of electricity and heat from CHP technologies. Additionally, a reasonably large selection of methods is given for the PEF calculations that differ significantly in their methodology, as seen in the overview given in Table 4.

**Table 4** Overview of the different allocation methods suggested by the different policy documents within the “Clean energy for all” package.

Policy related document	Allocation method				
	<i>Energy</i>	<i>Exergy</i>	<i>AGM<sup>(1)</sup></i>	<i>Residual heat</i>	<i>Power loss</i>
RED	x				
EED			x		
EPBD (referring to EN 15316)		x <sup>(2)</sup>	x	x	x

<sup>(1)</sup> AGM = Alternative generation method, also called the “Finnish” or “Benefit” method.

<sup>(2)</sup> Referred to as the Carnot method within the EN 15316 standard.

### **2.2.3 Geothermal energy within EU climate and energy policy**

Geothermal power plants can be found in 11 European countries, where Turkey, Italy, and Iceland are in the lead in terms of generated electricity due to their access to vast high-temperature resources (Huttrer, 2020). Direct utilization is reported in 34 European countries. Sweden, Germany, and Finland have extensive use of geothermal ground source heat pumps, while Iceland, Turkey, France, Germany use geothermal resources directly for space heating. Turkey, Netherlands, Russia, and Hungary use geothermal energy to heat greenhouses and ground heating to grow vegetables and flowers (Lund and Toth, 2020). Geothermal energy is furthermore particularly suited for combined heat and power (CHP) production in locations where there is access to geothermal resources in close vicinity to heat demand. Geothermal CHP plants can be found in various locations worldwide, examples including Austria, Germany, Iceland, USA, and Thailand (Lund and Chiasson, 2007, DeLovato et al., 2019).

Although geothermal utilization is widespread across the EU, the share of the resource in primary energy use is low, and it is not well represented in the EU policy documents of the “Clean energy for all” package. The RED categorizes geothermal energy as a renewable energy source (European council directive, 2018c). It encourages new infrastructure to allow for district heat from geothermal energy sources (among other renewable heat sources). Furthermore, the RED defines calculation procedures for renewable energy demand and certification requirements for the use and installation of geothermal heat pumps for heating and cooling purposes. The EED mentions geothermal energy as one of the renewable energy sources that should be considered for economical analysis of heating and cooling purposes (Part III of the EED (European council directive, 2018b). Lastly, the EPBD does not mention geothermal energy in particular. All in all, geothermal energy is most often mentioned in connection with heating and cooling demand within the “Clean energy for all” package, while its use for electricity generation or CHP generation is not discussed. When reflecting on the high PEF for geothermal as discussed in Subsection 2.1.1, it is surprising that the issue is not addressed in the EED on how increased use of geothermal resources within the EU could countereffect the target of increased energy efficiency.

## 3 Research methodology

This study investigates how electricity and heat from high-temperature geothermal resources correspond to the current EU energy and climate targets. The EU targets focus on greenhouse gas emission and energy efficiency of energy technologies. Furthermore, they require an analysis of the whole value chain of the energy product, from resource extraction to the end-user. Life cycle assessment is the most prominent method to assess environmental impacts and resource use over a product's or service's entire life cycle. Life cycle assessment is, therefore, the chosen methodology of the overall study. Furthermore, the study bases its research on a case study approach. These two methodological choices are discussed in the below sections.

### 3.1 Life cycle assessment

Life cycle assessment (LCA) is a standardized methodology to assess different environmental impacts of products, processes, systems, and services (hereafter called products) holistically (Hellweg and i Canals, 2014, Klöpffer, 1997, Guinée et al., 2011). It systematically addresses the product's up-and-down-stream processes across its entire value chain (from cradle-to-grave). A life cycle model of a product, defined as the product system, typically includes the acquisition of raw materials, the production of components, the use or operation of the product and its maintenance, and finally, its end-of-life handling such as waste treatment or recycling. It models all the inputs and outputs of materials, energy, and emissions throughout all those processes.

Energy inputs are needed in the vast majority of LCA studies of products, services, and processes since almost all require the use of energy of some form (Curran et al., 2005, Treyer and Bauer, 2013). To correctly represent the intrinsic environmental impacts associated with the energy use in LCAs, quality life-cycle inventory data (LCI) and LCA results for different energy production systems have to be accessible in databases or literature. In this study, the focus is set on supplying life cycle inventory data (LCI) and analyzing the life cycle environmental impacts (LCIA) of electricity and heat generation from high-temperature geothermal resources as a mean to provide quality data for the field of LCA studies and to show how LCA studies can be used to evaluate climate and energy policy implications.

Figure 6 shows a relevant example of the life cycle of a geothermal CHP plant producing hot water and electricity. LCA allows for an analysis of the environmental impacts associated with all these life cycle stages of the geothermal CHP plant, while other methods often only address the operational stage. Thus, LCA gives a holistic view of a product, process, or service's environmental impacts. Often, LCA analysis reveals otherwise hidden impacts, e.g., during resource acquisition and manufacturing of components, that otherwise would not have been associated with the product, service, or process itself. LCA's main limitation is that it does not cover all potential environmental impacts associated with a product and is thus limited to the available environmental impacts in LCA methodology. Furthermore, the accuracy of LCA assessment is subject to several different factors, such as the data quality used to model the product, the robustness and maturity of the methodology used to assess the

impacts, and the design of the LCA study regarding which processes are included or excluded in the analysis (ISO, 2006b).

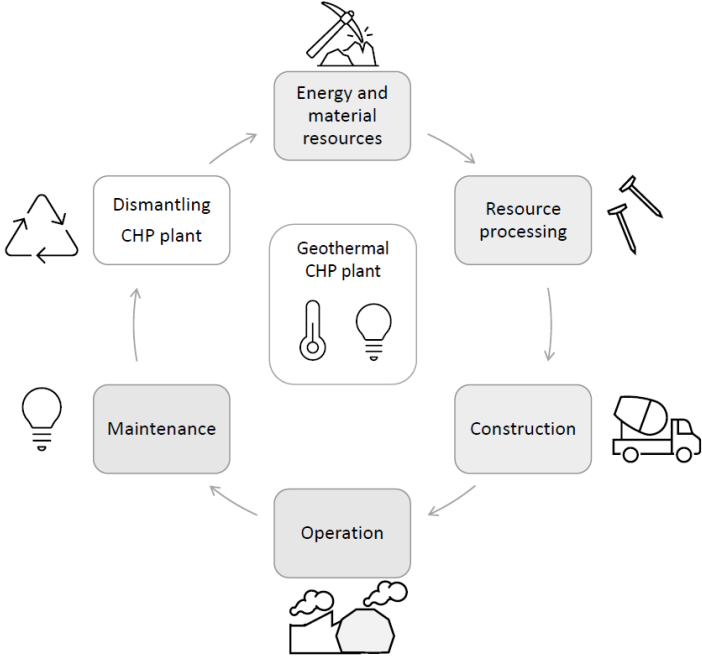

**Figure 6** A geothermal CHP plant's life cycle includes different stages, from the extraction of resources to the end of life or dismantling.

The International Organization for Standardization (ISO) has published guidelines on how LCA studies should be performed in the ISO 14040:2006 and ISO 14044:2006 ISO (ISO, 2006a, ISO, 2006b). Four phases of performing an LCA are defined in the standards as; goal and scope definition, the collection and analysis of the life cycle inventory (LCI), the life cycle impact assessment (LCIA), and interpretation of results. Figure 7 shows how the published papers in the study cover these four different phases of the LCA.



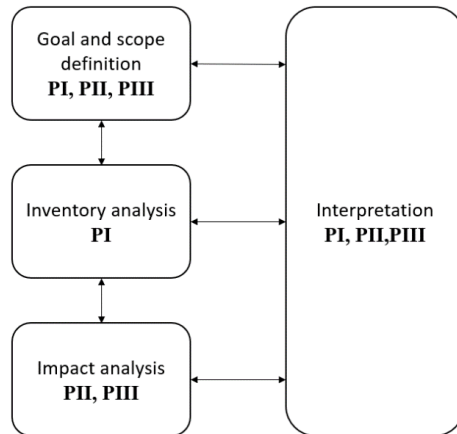

**Figure 7** The LCA according to the ISO 14000 series, with references to each published paper (adapted from (ISO, 2006b)).

The following sections will briefly discuss these different LCA methodology steps based on the ISO standards (ISO, 2006b, ISO, 2006a).

### 3.1.1 Goal and scope

The goal and scope of an LCA study describe the study's purpose and how it is executed. The scope includes a description of the product system, the functional unit of the system, what is included and excluded in the product system (the system boundary), how to separate environmental impacts between multiple products from multifunctional systems (allocation method), which environmental impacts are going to be studied (impact categories) and by which method (impact assessment method), what data are to be used for the assessment, as well as overall discussion on limitations and validation of the LCA.

The study's goal and scope are discussed in detail on different levels of the study in **PI-III**. Figure 8 shows how the product system of a geothermal CHP plant was defined in the study. Since a CHP plant is a multifunctional system, there are two defined functional units; 1 kWh of electricity and 1 kWh of heat. The most appropriate allocation method for a geothermal CHP plant is discussed in detail in **PIII**. The study's product system further shows how the end-of-life process of the CHP plant is omitted from the LCA. The study's intention was not to include electrical grid and district heating systems used to transport the products to the consumers within the system boundary since the focus is on the specific process of utilizing geothermal energy for energy production.

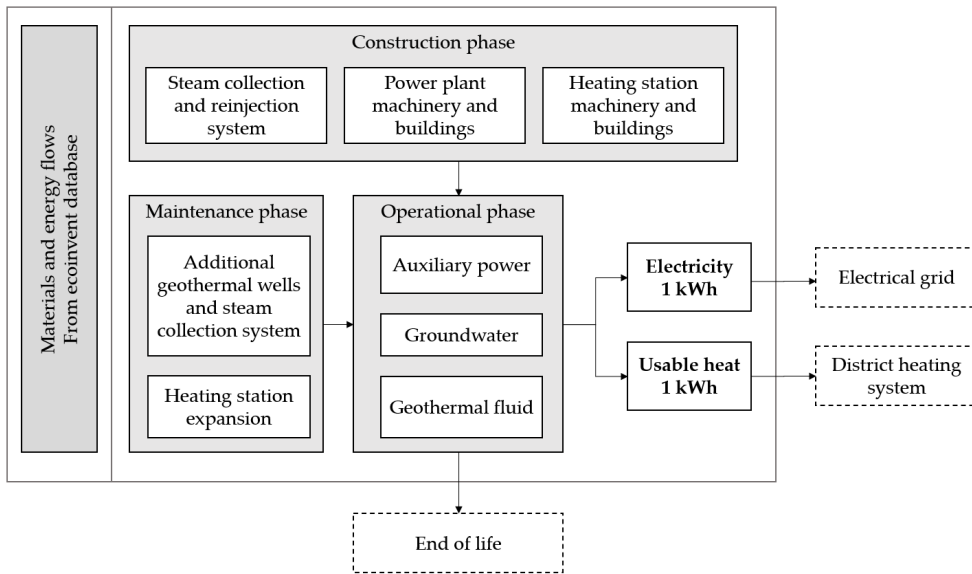

**Figure 8** The product system used for the LCA model of a geothermal CHP plant. The system boundary shows which unit processes are included and excluded in the study.

### 3.1.2 Inventory analysis - LCI

The inventory analysis covers the data collection for all the relevant inputs and outputs for the unit processes modeled and the interpretation of the data. The data collected for an LCA study can be of either primary or secondary origin. Primary data refers to data collected for the specific product under investigation, e.g., direct measurements of materials used or emissions from the process. In contrast, secondary data refers to the use of assumptions, literature, or databases to collect data for a part of or all the unit processes within the product system. **PI** discusses in depth the inventory analysis of the study and publishes the resulting dataset for a geothermal CHP plant with the intention of making it available as secondary data in other LCA studies of geothermal energy systems.

### 3.1.3 Impact analysis - LCIA

Impact analysis in LCA (referred to as LCIA) refers to further analyzing the inventory data and translating the inventory data into potential environmental impacts. Characterization factors are used to evaluate each input's and output's significance in the LCA model and convert them into the relevant unit of impact according to their relative contribution (ISO, 2006b, ISO, 2006a). For example, methane (CH<sub>4</sub>) is a greenhouse gas that is converted into a standard unit of CO<sub>2</sub> equivalent emissions, different toxic chemicals into 1,4-dichlorobenzene equivalents, and energy use into a standard unit of energy in terms of kilojoules (kJ), or megawatt-hours (MWh), of non-renewable or renewable energy. Furthermore, these environmental impacts are categorized into impact categories, such as global warming potential (GWP), human toxicity potential (HTP), and cumulative energy demand (CED) for the characterization factor examples given above.

The examples given above for different LCIA categories are all so-called midpoint categories that describe potentials. Methods have also been developed that convert midpoint categories, such as GWP and HTP, to endpoint categories that communicate further on the consequences or the damage of the impacts (Jolliet et al., 2003). Both these approaches to delivering LCIA results have been concluded beneficial for the application of LCA in decision making, policymaking, and for scientific purposes, but the endpoint approach is considered with higher uncertainties due to the many assumptions made in converting midpoint impacts to endpoint impacts (Bare et al., 2000).

There are multiple available impact assessment methods for LCA applications developed by different scientific institutions or cooperations. Examples are; CML-IA baseline method covering a set of 10 commonly used impact categories for a midpoint approach on a European scale (Guinée, 2002), ReCiPe 2016 that include four endpoint and 18 midpoint impact categories on a global scale (Huijbregts et al., 2017), and TRACI 2.1 that is specifically developed for the U.S (north-America) as a midpoint method with ten impact categories (Ryberg et al., 2014). The Product Environmental Footprint (PEF) method, based on the ILCD method (EC-JRC, 2011), is a promising LCIA method being developed for the European context intended as a standard for future environmental impact assessments (European Commission, 2013) Furthermore, some LCIA methods are developed for a narrower analysis of a specific topic, such as for energy analysis in the CED (cumulative energy demand) method that gives results for five different energy-related impact categories (Hischier R. et al., 2010).

This study applies the CML-IA baseline and the CED methods for the LCA of the geothermal utilization for heat and power production, as these two methods combined covered the needs of the study in terms of the research questions developed. The methods are discussed in **PII-III**, where the LCIA results are presented. It became evident within the study that impact assessment methods are not fully developed for all substances that can occur as inputs and outputs in LCA studies. One of the most developed methods is the contribution of different greenhouse gases to global warming, which is a global impact. However, many local impacts are challenging to assess in detail (Bare, 2014). Further research is needed for many substances, including one of the main emissions from high-temperature geothermal utilization, namely hydrogen sulfide (H<sub>2</sub>S), as discussed in Section 5 of the dissertation. The LCIA method was manually altered in the study's modeling phase to include the relevant characterization factor for translating H<sub>2</sub>S emissions into acidification potential to better account for its relevant impacts.

### **3.1.4 Interpretation – LCA and policy implications**

In the last phase of an LCA study, the results from the previous phases are evaluated against the goal and scope of the study. Furthermore, it is intended to identify the limitations, as well as giving concluding remarks and further suggestions based on the results (ISO, 2006b).

In the study, the LCA application's main purpose was to evaluate the results against the main EU climate and energy policy targets for 2030. **PIII** delivers the interpretation phase regarding these policy implications based on the LCA results published in **PII-III**. Furthermore, **PI** delivers interpretation on the LCI results in particular.

## 3.2 Case study approach

The LCA applied in the study is a single case study of a state-of-the-art, high-temperature geothermal combined heat and power plant located in Iceland. A single case study approach allows for a detailed investigation of a single, often selected rather than random, case to understand a phenomenon (Ridder, 2017). In LCA, case studies are of high practical value. They often present reliable data, shed light on a specific topic, effectively test current claims, or expand life cycle thinking into new areas (Klöpffer and Curran, 2014). However, case studies have been criticized as a research strategy, i.e., due to their inherent lack of generalizability (Yin, 1981). Case studies are considered a valid research strategy, and many researchers have defended their application. They claim they are essential to theory building (Eisenhardt and Graebner, 2007), to systematically produce exemplars in scientific disciplines (Flyvbjerg, 2006), and to examine phenomena in their real-life contexts (Yin, 1981). In fact, Flyvbjerg (2006) argues that:

*“A scientific discipline without a large number of thoroughly executed case studies is a discipline without systematic production of exemplars, and that a discipline without exemplars is an ineffective one.”*

The single case study approach was selected here due to the scarcity of such studies within the field of LCA and high-temperature utilization. Due to this scarcity, it was impossible to construct generalizable or comprehensive results for measuring the different aspects of high-temperature utilization in terms of climate and energy policy perspectives. Instead, the case study approach allowed for an addition to be made in LCA research on geothermal applications to develop further a comprehensive selection of detailed LCAs that eventually serve as a strong basis for theory building.

The selected case is the Hellisheidi geothermal combined heat and power plant, located in South-West Iceland, close to Reykjavik's capital city. It was explicitly chosen to investigate geothermal utilization's potential compliance with current EU energy policy in ranking different energy technologies as viable for future energy systems. The Hellisheidi plant is an excellent representative of a state-of-the-art geothermal CHP plant and one of the largest of its kind worldwide. Therefore, it may be considered a “polar type case study” (Eisenhardt and Graebner, 2007) as it represents a very high-performing case to serve as a benchmark in future studies.

Additionally, the Hellisheidi plant has a modular design, meaning that its components can be broken down into sub-modules representing a specific technology commonly used in power plant design for geothermal plants. The modules, a single flash stage, a double flash stage, and a thermal plant, can all be assessed individually to represent these three different utilization designs. The organization of **PI** made use of the modular design by presenting LCI for the different sub-modules so that LCA practitioners could use the publication as a reference or a benchmark for more than one type of geothermal application.

Furthermore, the value of choosing Hellisheidi as a case study is (i) the plant produces over 40% of the total electricity from geothermal plants in Iceland and thus represents a large part of the overall environmental impacts from geothermal power plants in the country, and, (ii) the plant is recently built, and its owners provided access to reliable data to construct the LCI. More details regarding the Hellisheidi case study are found in **PI-III**.

## 4 Study results

The dissertation study was set to investigate the research question:

*“Should geothermal energy be a part of our future energy systems to battle climate change and our non-sustainable use of resources?”*

Within the scope of the study, geothermal energy has low environmental impacts compared to fossil fuel energy resources. This supports the claim that, under favorable conditions, geothermal energy should be considered an attractive energy technology to replace the use of fossil fuels in today's and future energy systems. **PI-III** provide a consistent approach to the overall research question, from the necessary data investigated and published in **PI** to a full LCA on high-temperature utilization published in **PII**. Finally, it compares the LCA results to the main targets of the current EU climate and energy policy in **PIII**.

The following subsections will highlight the main results for the set of sub-questions related to the research question, each discussing the following topics: *Greenhouse gas emissions, other life cycle environmental impacts, primary energy efficiency, and EU policy implications* for geothermal utilization.

### 4.1 Greenhouse gas emissions

The first sub-question of this dissertation, **SQ1**, as presented in Section 1.2, is “How does geothermal utilization contribute to lowering GHG emissions from the energy sector?”

Emissions of greenhouse gases (GHG) are among the most studied environmental impacts of energy technologies and a determining factor for their inclusion in future energy systems in current energy policies. To answer this question, the life cycle assessment of GHG emissions from high-temperature geothermal utilization is a central topic in **PII** and **III**. They aim to locate the technology on the emission factor spectrum of energy technologies. The main results show that GHG emissions per produced energy unit from the case study of high-temperature utilization and most other published LCA studies on geothermal utilization are an order of magnitude lower than from fossil energy technologies and in line with other renewable and low-carbon technologies. However, published LCA studies on geothermal utilization are scarce and there exist known instances of extremely high GHG emissions from a few geothermal fields. The results also show that the emission factor is highly sensitive to the allocation method used to divide the GHG emissions between electricity and heat produced from a CHP plant, especially for heat production. The individual paper contributions to the research question are discussed further below.

**PII** is derived from the published LCI in **PI** and focuses on an in-depth analysis of the case study's life cycle environmental impacts, including the global warming potential (GWP) of electricity and heat from a specific high-temperature geothermal CHP plant. The operational phase is the main contributor to the GWP due to the direct emission of CO<sub>2</sub> originating from geothermal steam. This contrasts with most LCA studies on low-temperature geothermal utilization, where GHG emissions' primary origin is associated with the power plant's

construction phase. The difference between low- and high-temperature geothermal resource utilization lies in the energy conversion technology and its geochemical characteristics. Additionally, direct GHG emissions can vary significantly between different high-temperature geothermal sites since geothermal fluid's chemical characteristics are very site-specific (Fridriksson et al., 2017).

The case study's results show a relatively low value of the GWP compared to other publications for geothermal plants and conventional electricity generation technologies. Figure 2 in Section 2.1.1 shows results for LCA GHG emissions from different electricity generation technologies, collected by the IPCC special report on renewable energy sources and climate change mitigation (SRREN), where results for geothermal ranged from 6 to 79 g CO<sub>2</sub> eq/kWh (Moomaw et al., 2011). The results for electricity from the Hellisheidi CHP plant's case study, calculated as GWP100, are 15.9 g CO<sub>2</sub> eq/kWh. They fall below the 25<sup>th</sup> percentile of the range given for reviewed LCA studies on geothermal by Moomaw et al. (2011). Similar results are found for the production of heat. The study applies the “energy allocation” method that results in an even distribution of GHG emissions per useful energy unit produced from the CHP plant. In the case of heat, the emission factor is very low in **PII** compared to other commonly used heat technologies.

**PII** also investigates two operational scenarios for the case study; a base-case and mitigation measures implemented to lower the GWP. The mitigation measures scenario is based on fully implemented and tested solutions by the actual CHP plant in the case study. They involve using the Carbfix carbon capture and storage (CCS) technology (Aradóttir et al., 2015) and replacing fossil fuels with electricity in drilling activities. The LCA results indicate that mitigation measures already implemented have the potential to reduce the GWP by roughly 30% for each unit of heat and electricity produced over the 30-year operational time under investigation. There is an even greater potential for further reduction of GWP by up-scaling the Carbfix technology on site.

**PIII** further investigates the effects of different allocation methods commonly applied to CHP production. Figure 9 shows the sensitivity of the selected allocation method on the results for GWP for electricity and heat from a CHP plant, especially for the case of heat production. The results showcase how the allocation method can be selected to benefit either energy product, electricity, or heat, to lower their emission factor. The lowest emission factor for heat is obtained with the “Electricity allocation” and the highest with the “Energy allocation” method, with results varying from 0.7 to 15.7 g CO<sub>2</sub> eq/kWh. Still, the range of emission factors for geothermal electricity and heat falls well below other energy technologies used for comparison in **PII**.

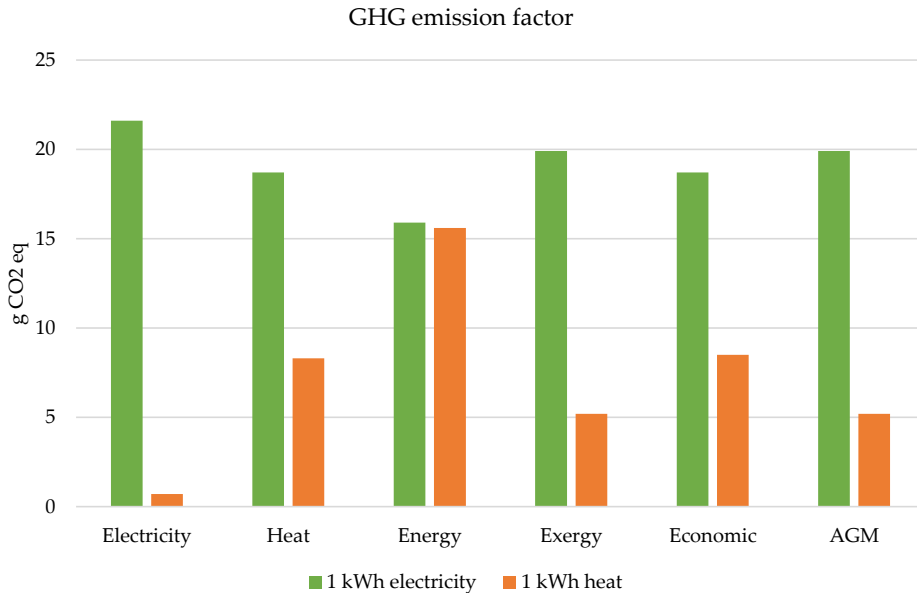

**Figure 9** The results for GHG emissions for electricity and heat produced from the case study according to the allocation method used.

The general conclusion of the study for **SQ1**, based on the case study results, can be applied to other geothermal projects that use similar conversion technology and have geochemical characteristics within the same order of magnitude. It cannot be stated that the conclusion covers all high-temperature geothermal projects due to extremities that have been found, resulting in very high CO<sub>2</sub> emissions per kWh and within the same range as fossil fuel technologies. Those instances are, however, rare. The application of the mitigation methods showcased in the study can potentially be applicable in most geothermal sites to reduce the GHG emissions of geothermal utilization. The issue of case study implications will be covered in the discussion section.

## 4.2 Other environmental impacts

**SQ2** of the thesis is the following: “*Are there any negative life cycle environmental impacts other than carbon emissions that affect the potential of geothermal utilization to be a part of future energy systems?*”

From the environmental impact categories analyzed within the scope of the study, two stood out as “hotspots” for geothermal utilization compared to other energy technologies. Those are the acidification potential (AP) and the abiotic resource depletion potential (ADP). The direct emission of H<sub>2</sub>S is the main contributor to the AP and has to be adequately managed in geothermal projects for them to be accepted as having high environmental performance. The ADP is in line with hydropower and has little potential to be reduced with current technology due to geothermal systems’ extensive infrastructure. Therefore, the relevance of these downsides of geothermal utilization has to be weighed against the benefits, e.g., the low

GWP, before implementing a geothermal project. The contribution of the papers to this question is explained below.

**PII** presents LCA results for multiple environmental impacts other than the GWP. It compares the overall LCIA results to other studies for investigating if geothermal utilization has any adverse effects, although having a low GWP. The paper highlights the importance of applying life cycle thinking, such as LCA methodology, when analyzing the environmental impacts of products or processes, as downstream processes, such as construction, manufacturing, and material acquisition, are otherwise often not addressed.

The work published in **PI** is of particular importance to analyze the various environmental impacts other than the GWP for geothermal utilization. There was no access to reliable and detailed LCI for high-temperature geothermal energy production processes before its publication, even though some LCA databases included processes for geothermal electricity. However, when further analyzed, the data originated from studies on low- to medium-temperature geothermal technologies or EGS (enhanced geothermal system) technologies that are substantially different from the flash technology used in high-temperature geothermal utilization.

The case study's impact assessment results are relatively low in most of the analyzed categories, often by order of magnitude compared to other technologies. The exemptions are the acidification potential (AP) for both heat and electricity and the abiotic depletion potential (ADP) for electricity production. In fact, the AP is the main hotspot for geothermal utilization in the LCA analysis compared to other technologies. The AP is a very specific environmental impact for high-temperature geothermal utilization. The emission of H<sub>2</sub>S, which is the main contributor to the AP in the LCA analysis performed, is common from such applications while uncommon from other energy technologies. Studies on the impact of H<sub>2</sub>S emissions on human health and the environment are scarce and, in some cases, non-conclusive. It is, however, well known that the gas is poisonous in high concentrations. The analysis of the environmental impact of atmospheric H<sub>2</sub>S emissions is also scarce in LCA methodology, and it is often not included as a contributor to the AP, and possibly other impact categories, for that reason. The AP calculation method had to be modified in **PII** to include the characterization factor for H<sub>2</sub>S. Therefore, it is likely that other LCA studies on geothermal utilization have not pinpointed the gas as a major source of environmental impacts due to the missing characterization factor in default calculation methods for impact assessment available in LCA software.

The ADP derives from the material-intensive construction process of geothermal plants, mainly due to the drilling and structural composition of the geothermal wells and the construction of a large steam gathering system to collect the geothermal fluid and transport it to the plant site. As mentioned before, the ADP is similar for geothermal and hydropower as these technologies are quite material-intensive in the construction phase, while it is much lower for, e.g., gas power plants.

The mitigation methods investigated in **PII** for GHG mitigation also result in lowering the impact of H<sub>2</sub>S. The CCS technology (Carbfix method) at the CHP plant is evenly applicable to H<sub>2</sub>S (also called the Sulfix method) (Gunnarsson et al., 2018, Marieni et al., 2018). **PII** shows how the AP is reduced by 62-63% for each unit of electricity and heat after implementing the Sulfix method for capturing and permanently mineralizing H<sub>2</sub>S below ground. These results should apply to other geothermal sites where H<sub>2</sub>S is one of the



dominant gases dissolved in the geothermal fluid and released during utilization. To be able to identify this hot spot for geothermal, the modification of the AP calculation methodology to include a characterization factor for H<sub>2</sub>S is essential.

In conclusion, the results from **PII** indicate a very high environmental performance of the case study in most of the impact categories investigated compared to other energy conversion technologies. However, hotspot analysis puts focus on reducing H<sub>2</sub>S emissions to improve the environmental performance of geothermal plants further. The overall results emphasize the potential of geothermal energy to be a clean source for producing electricity and heat, with appropriate mitigation methods applied to minimize adverse environmental impacts.

### 4.3 Primary energy efficiency

**SQ3** poses the question: “*What is the primary energy efficiency of the geothermal CHP plant? What is the share of non-renewable sources in its primary energy consumption based on the cumulative energy demand calculation methodology in LCA?*”

**PI**, **II**, and **III** all contribute to the answer on how the flow of energy to and from the geothermal plant constitutes the plant's primary energy efficiency. They show that the primary energy factor (PEF), which is the inverse of the primary energy efficiency, is almost solely of renewable origin stemming from the inflow of geothermal energy from the natural resource. Furthermore, the PEF for geothermal is very high compared to other energy technologies, both renewable and non-renewable, which results in low primary energy efficiency. The reason is the low thermodynamic efficiency of geothermal applications due to relatively low temperatures available from natural geothermal resources compared to the operating conditions of other thermal energy sources.

**PII** and **III** explore the primary energy efficiency of the case study in comparison with other geothermal plants and other energy technologies. **PI** covers the thermodynamic energy flows, describing the inputs of primary energy from the geothermal resource and outputs of energy in the form of useful energy products and waste heat to and from the energy conversion system. **PII** then presents how different life cycle stages in geothermal utilization affect the primary energy efficiency in terms of the impact category Cumulative energy demand (CED). For the case study, the CED is dominated by the primary and renewable energy input of geothermal throughout the operational phase of the CHP plant. An insignificant fraction of the CED stems from other life cycle phases and has a non-renewable origin, mostly from diesel use in drilling activities and construction machinery on-site, as well as from the energy used in various manufacturing processes of materials used to construct and maintain the CHP plant. In the case study, these manufacturing processes occur in countries where the electricity mix has a substantial non-renewable origin. The overall result is that the CED for geothermal is almost entirely based on renewable energy resources. In the EU's energy policy, the CED is equivalent to the Primary Energy Factor (PEF) used to express different energy technologies' primary energy efficiency.

**PIII** further discusses the PEF of the case study and geothermal utilization in general and compares it to other energy technologies. The PEF for geothermal is found to be much higher than all other PEFs for the different energy technologies, making geothermal the least attractive energy resource to meet targets of increased energy efficiency. However, it is almost entirely based on a renewable energy source, contrary to fossil energy technologies. **PIII** also discusses the effects of different allocation methods for CHP plants on the PEF. The

significant variations in the PEF for heat and electricity based on different allocation methods can be seen in Figure 10 for both the total PEF and the non-renewable part of the PEF (PEF\_non-ren).

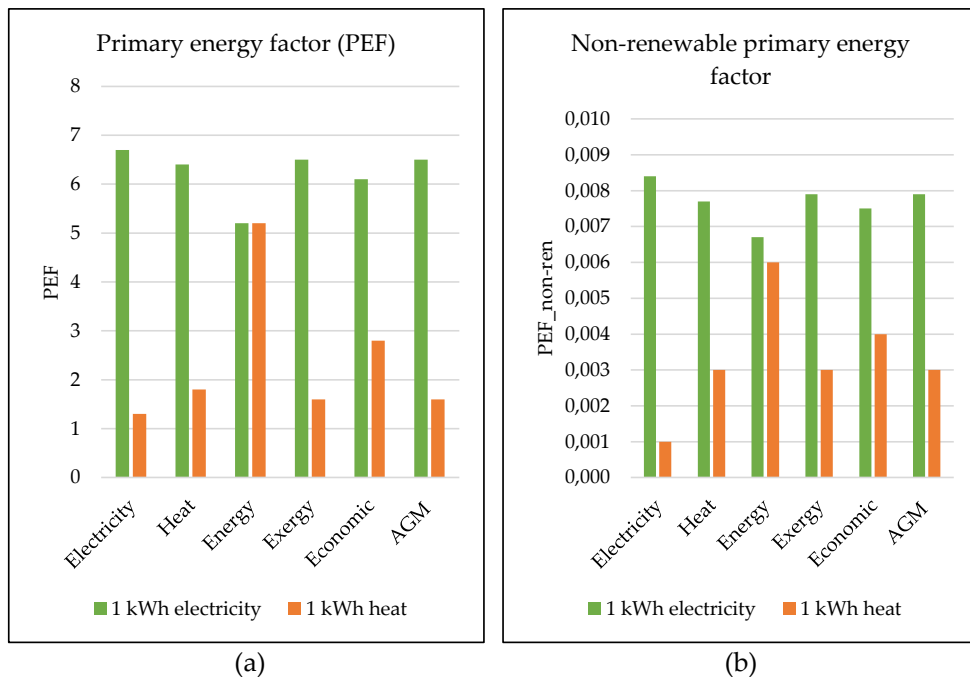

**Figure 10** The variation of results for (a) the total PEF and (b) the non-renewable PEF according to the allocation method used. The non-renewable PEF presents the sum of all non-renewable energy inputs (non-renewable biomass, nuclear, and fossil fuels) needed to produce 1 kWh of electricity or 1 kWh of heat.

## 4.4 Policy implications

The last sub-question, **SQ4**, addresses the following: “How does high-temperature geothermal energy technology compare to current EU climate and energy policy?”

The main contribution to **SQ4** is found in **PIII**, which focuses on GHG emissions and the PEF of producing electricity and heat with high-temperature geothermal resources and relates the results to the EU climate and energy policy. It derives from the LCA results of **PII** to showcase how geothermal utilization compares to the three main policy targets. The results from **PIII** indicate that geothermal utilization for electricity production does not fit well into the current policy framework as it counteracts the target of increased primary energy efficiency. In fact, replacing any energy technology with geothermal technology results in increased primary energy use due to the high PEF value of geothermal, and therefore lower energy efficiency. However, the use of geothermal energy supports both the climate target of lower GHG emissions and the renewable energy target of increasing the share of renewables within the EU’s energy system. These non-conclusive implications of the EU policy on the future of geothermal utilization need to be addressed further to set a clear pathway for the development of geothermal energy for electricity production in Europe. The current calculation method of the primary energy content of geothermal resources could be revised to

resolve this issue, or the use of primary energy as a target measure could be reconsidered. The policy would be a stronger promoter of geothermal utilization if it focused on the final energy use when setting energy demand reduction targets or setting targets on reducing non-renewable primary energy use instead of total primary energy use.

**PIII** also addresses the allocation dilemma of combined heat and power production. It points out that supporting policy documents for the EU climate and energy policy targets provide non-consistent approaches to allocating GHG emissions and primary energy demand to electricity and heat.

## 4.5 Overview of research structure and results

A short overview of the research question and the contribution of each publication is given in Figure 11. The key findings of each publication and a general conclusion of the study are also presented in the figure.

<b>Research question:</b>			
<i>“Should geothermal energy be a part of future energy systems to battle climate change and non-sustainable use of resources?”</i>			
<b>Sub-questions 1-4:</b>			
<b>SQ1:</b> <i>How does high-temperature geothermal utilization contribute to lowering GHG emissions from the energy sector?</i>			
<b>SQ2:</b> <i>Are there any adverse environmental impacts other than GHG emissions that affect high-temperature geothermal utilization potential to be a part of future energy systems?</i>			
<b>SQ3:</b> <i>How does the primary energy efficiency concept relate to geothermal energy technologies, and how substantial is the share of non-renewable energy demand during the life-cycle of such technologies?</i>			
<b>SQ4:</b> <i>How does high-temperature geothermal energy technology compare to the current EU climate and energy policy?</i>			
	<b>PI</b>	<b>PII</b>	<b>PIII</b>
<b>Title</b>	Life cycle inventory of a flash geothermal combined heat and power plant located in Iceland	Life cycle assessment of a geothermal combined heat and power plant based on high-temperature utilization	High-Temperature Geothermal Utilization in the Context of European Energy Policy—Implications and Limitations
<b>Purpose</b>	<p>(i) To construct a detailed LCI dataset for a specific case study as a foundation for further LCA analysis.</p> <p>(ii) To provide reference LCI data for high-temperature geothermal heat- and power generation technology for use in other LCA studies since available data are scarce.</p>	<p>(i) To investigate the life cycle environmental impacts of high-temperature geothermal heat and power production.</p> <p>(ii) To examine the contribution of different life cycle stages of high-temperature geothermal heat- and power production to the overall environmental impacts to see if hidden impacts occur in upstream or downstream life cycle stages compared to the operational stage.</p> <p>(iii) To investigate the effects of operational improvements implemented during the first decade of operation of the Hellisheidi CHP plant on the overall life cycle</p>	<p>(i) To investigate how high-temperature geothermal utilization for electricity and heat production measures up to current EU energy and climate policy under the „Clean Energy for All Europeans“ package.</p> <p>(ii) To showcase the effects of different allocation methods on the results of the two leading environmental indicators used in EU climate and energy policy, highlight the need for a clear definition of what method to apply to combined heat and power production.</p> <p>(iii) To discuss the definition of Primary Energy Content of geothermal resources and how it possibly affects geothermal</p>

		environmental impacts compared to a base case scenario.	development due to adverse effects on the EU energy efficiency target.
<b>RQ contribution</b>	Contributes to <b>SQ1, SQ2, and SQ3</b>	Contributes to <b>SQ1, SQ2, and SQ3</b>	Contributes to <b>SQ1, SQ3, and SQ4</b>
<b>Key findings</b>	LCI dataset for main processes involved with high-temperature geothermal utilization is presented in multiple tables. The gathered LCI can be applied as reference data for high-temperature geothermal utilization, as roughly 60% of all electricity from geothermal resources is produced with the presented technology. However, site-specific data on geothermal resource characteristics and must be collected for each case as these vary greatly between geothermal resources and can severely alter the LCA results between different cases.	LCA results for the case study indicate a very high environmental performance of high-temperature utilization compared to other conventional heat and power production technologies. All impact category results for geothermal electricity were an order of magnitude lower than for a generic gas-fired power plant, except for AP and APD. Most impact categories were affected by construction stage processes, but significant environmental impacts also originated from direct emissions from the geothermal CHP plant. Furthermore, two means of minimizing environmental impacts from geothermal utilization were discussed based on the operational experience of the case study.	Geothermal has the potential to take part in the EU achieving its climate and energy targets. The definition of the primary energy factor, or more explicitly the primary energy content of a geothermal resource, does limit geothermal energy for being successful in terms of improved energy efficiency measures unless the measures are against lowering the non-renewable primary energy use instead of the total primary energy use. The need for assigning an appropriate allocation method for CHP to calculate primary energy factors, energy savings, and GHG emissions from co-generated electricity and heat in context with EU energy and climate policy is furthermore of crucial importance.
<b>Conclusions:</b>			
<p><i>CO<sub>2</sub> emissions from the energy sector can be lowered substantially if geothermal energy would be utilized more extensively to replace the use of fossil fuels for energy production. Furthermore, utilizing geothermal energy more extensively contributes to increasing the share of renewable resources in future energy systems. However, an identified trade-off regarding other environmental impacts is increased acidification potential compared to other conventional technologies. Additionally, the thermal efficiency of converting geothermal energy to electricity is low and can countereffect the EU energy policy targets of reaching increased energy efficiency in terms of primary energy use across the EU's energy system.</i></p>			

**Figure 11** Overview of the research design and how the individual papers contribute to answering the research question.



## 5 Discussion

The study shows that geothermal utilization can, in the right context, provide electricity and heat in a cleaner and more sustainable manner than some other more conventional energy technologies, such as those that utilize fossil fuels. In the studied case, the potential life cycle environmental impacts of geothermal technology, including global warming potential, were substantially lower than for conventional fossil-fuel-based energy technologies, with a few exemptions on impact categories where scores were higher. However, the acidification potential is substantially higher for geothermal due to its characteristic hydrogen sulfide (H<sub>2</sub>S) emission. The use of LCA to holistically analyze energy technologies thus allows identifying such trade-offs.

Regarding the policy implications, the results indicate that geothermal utilization for electricity production does not fit well in the current EU policy framework. It counteracts the target of increased energy efficiency based on primary energy use, as geothermal utilization's primary energy efficiency is amongst the lowest of all energy technologies. At the same time, geothermal contributes positively to the targets of an increased share of renewables and reduced GHG emissions. These contradicting results show how important it is for interdisciplinary stakeholders of different technologies to participate actively in policymaking and international platforms where industry rules and definitions are agreed upon. In the case of high-temperature geothermal utilization, the definition of its primary energy content needs further discussion and acknowledgment of its implication on energy efficiency-based targets. Efficiency-based targets to reduce global emissions and resource depletion are found in EU energy policy and, e.g., the United Nations Sustainable Development Goals (SDGs) (IAEG-SDGs, 2017). If current definitions of primary energy content and targets based on primary energy savings will prevail, further development of geothermal energy will contradict those targets each time a new geothermal project is considered in an energy system. This is undoubtedly not the intention of the current energy policy.

The following subsections give an overview of the thesis's theoretical and practical contributions, along with the limitations that need to be taken into account when evaluating the study's robustness.

### 5.1 Dissertation contribution

The dissertation provides both practical and theoretical contributions to the different topics and methodologies applied within the study. In the sections below, these are reviewed and discussed.

#### 5.1.1 Life cycle assessment

LCA is gaining much momentum as a research methodology, particularly in research projects funded by EU's Horizon 2020. There, multiple projects on geothermal technologies include LCA as a measure to report on environmental performance. Recent publications on geothermal utilization include reviews on LCA publications (Tomasini-Montenegro et al., 2017, Guðjónsdóttir et al., 2020), guidelines for geothermal LCA's to ensure their

comparability and harmonization (Parisi et al., 2020), and case studies for a variety of geothermal technologies in different countries (e.g., (Hanbury and Vasquez, 2018, Buonocore et al., 2015, Martinez-Corona et al., 2017)). These all add valuable knowledge to the field of LCA and geothermal applications. This dissertation is set out to do the same.

Two substantial practical contributions of the dissertation are highlighted under the field of LCA. The first is the publication of the detailed LCI in **PI**, which purpose was to publish data for other LCA practitioners to use in geothermal studies. The LCI described the flash technology that currently has had little attention in LCA studies on geothermal plants. Recently published studies have utilized either a part of the complete LCI from **PI** as a basis for their LCA results for geothermal applications (Paulillo et al., 2019, Wang et al., 2020, Tosti et al., 2020, Paulillo et al., 2020a). The second main practical contribution within the field of LCA is the publication of LCA results for the case study itself in **PII**,

The study also contributes to the theory of LCA within geothermal studies. It identifies the importance of further development of LCIA categories affected by atmospheric H<sub>2</sub>S emissions as these are characteristic emissions from geothermal applications. Furthermore, H<sub>2</sub>S emissions are identified as a hot spot for geothermal utilization when translated into acidification potential, compared to other energy technologies. **PII** discusses the issue of H<sub>2</sub>S not being included by default in the baseline impact assessment methods used in LCA software and proposes a manual addition of a characterization factor for the gas into LCIA methods to calculate acidification potential. The conclusion is supported by another study by Parisi et al. (2020) that identifies the same gap and makes the same suggestion. Additionally, this dissertation highlights the need to develop the impact assessment method for H<sub>2</sub>S emissions further as the current development status within the field of LCA is far from complete.

### 5.1.2 Primary energy efficiency

Primary energy efficiency, which translates into primary energy factors for different energy processes, is a central topic of this dissertation. The contribution of the dissertation is mostly of practical value. It tests the cumulative energy demand (CED) calculation methodology to produce a PEF for electricity and heat from geothermal energy resources using LCA modeling. The CED method proves to be successful in calculating the PEF for energy technologies if care is taken to collect and model accurate data on energy flows and energy-intensive input processes.

It also discusses the effects of subjective choices in current international energy statistics on primary energy definitions for different energy resources on the geothermal PEF. The dissertation shows, mainly through **PIII**, that the PEF value for geothermal energy is an outlier compared to other energy technologies, with much higher primary energy demand per produced unit of electricity than any other energy technology. An overview of published PEFs is given in Table 3 and shows this difference clearly. The main reason is the lack of consistency in defining the different renewable energy technologies' primary energy content. The primary energy content of geothermal energy is defined with the same method as non-renewable energy technologies, that is, by the IEA's "physical energy content" method based on thermal conversion efficiency. This results in a geothermal PEF for electricity close to the value of 10. Most other renewables' primary energy content is based on the "direct equivalent" method, assuming a 100% conversion efficiency between the renewable energy input flow and electricity output, resulting in a PEF value of 1 for most renewables. **PIII** presents an example of if physical energy content is used to define, e.g., solar photovoltaics'



primary energy content instead of the direct equivalent method, the PEF for solar-PVs would be closer to 4.5 rather than 1.0. This thesis's practical contribution is to highlight this difference between how PEFs are calculated for different energy technologies and the possible adverse implication on the role of geothermal utilization that does not affect other renewables. Actual examples are given by using the case study from **PI-II**. This is discussed further in the following subsection on energy policy.

### **5.1.3 Energy policy**

One of this study's main findings is how geothermal utilization can affect the EU climate and energy targets for 2030. Or even vice versa, how the EU 2030 climate and energy targets can potentially affect geothermal utilization development in Europe.

The previous subsection has already discussed how the PEF of geothermal electricity production results in a very high PEF value compared to other renewable technologies. One of the main targets of the EU's climate and energy policy relies on the PEF values for energy technologies to be as low as possible, namely the target of reduced primary energy use in 2030. The target states that by 2030, the primary energy use should not exceed 1 273 Mtoe, thus reaching a target of 32.5% increased energy efficiency across the energy value chain (European council directive, 2018b). Figure 3 shows how the energy efficiency target for primary energy use is visualized towards 2030 and its development up until 2018. The implication of how the PEF for geothermal is defined differently from other renewables is that increasing geothermal utilization within the EU would counteract this target. This is because every kWh of electricity originating from geothermal resources translates to roughly 10 kWh of primary energy use, while every kWh of, e.g., electricity from solar or wind, would translate to only 1 kWh of primary energy use. This thesis's contribution is to highlight this large difference and raise the question of whether this is acceptable if the intention is to promote the use of geothermal resources across the EU to increase the share of renewable resources and reduce the use of fossil fuels.

## **5.2 Evaluation of the research**

Assessing the quality and acceptability of research is commonly performed by evaluating the reliability and validity of the research methodology and the research results (Golafshani, 2003, Morse et al., 2002, Creswell and Miller, 2000). Evaluation of *reliability* in academic research deals with the consistency of the results and their accuracy. Consistency is reached, e.g., when the results can be reproduced when researched under a similar methodology and conditions (Golafshani, 2003). Evaluation of the research's *validity* discusses the extent to which the research is credible in measuring what it sets out to measure and its generalizability (Golafshani, 2003, Creswell and Miller, 2000).

This section of the dissertation discusses the research findings' reliability and validity by self-evaluation of the overall dissertation study and results.

### **5.2.1 Reliability**

The reliability of the two main approaches of the study used to answer the overall research question is evaluated below. These are; (i) the application of LCA methodology and (ii) evaluation of current EU climate and energy policy and its main strategic targets in context with the LCA findings.

### *Reliability of LCA application and results*

As for other LCA studies, the results in this study derive from the inventory data collected. Björklund (2002) discusses how LCA studies' reliability is strongly dependent on the quality of the collected life cycle inventory data. Uncertainties can be in the form of the inaccuracy of data, data gaps, and mistakes in data gathering, using static instead of dynamic modeling of data, e.t.c. Few published LCA studies address the significance of the uncertainties with qualitative or quantitative measures, and there is a lack of consensus on the methodology of assessing uncertainties in LCA (Björklund, 2002, Heijungs and Huijbregts, 2004).

**PI** thoroughly explains the data collection process and discusses, in particular, the reliability of the data collected and used throughout the study. The paper presents a qualitative assessment of the data quality and representativeness in terms of the data's temporal and geographical scope, the technology representatives, the data robustness, and a quantitative assessment of the data accuracy. The data collection process's design and execution resulted in the compilation of high-quality primary data for the LCA model's foreground processes, such as material flow for constructing the CHP plant and the energy flows during the operational phase of the plant. In addition, secondary data from reliable LCI databases were selected to represent background processes such as acquisition and production processes of materials. **PI** also systematically presents the case study's inventory data to ensure reproducibility of the study results and to publish secondary data for other studies in case of data gaps in future LCA studies on high-temperature geothermal technologies.

In **PII**, a Monte Carlo analysis investigates the LCA results' reliability based on the inventory data's reliability. It shows how the input data with the highest uncertainty values produce the highest variation in LCIA results. The GWP100 and CED-renewable impact categories, which were a strong focus within the study, showed a reasonably low variation in the results due to the underlying data's robustness. However, the CED results of non-renewable origin show more considerable variations due to the dependency on secondary data and the assumptions made with low accuracy in the LCA modeling. Since the CED of non-renewable origin only contributes marginally to the overall CED results, these uncertainties do not affect the study's overall conclusions on the research question.

As a result of the assessments on data quality and accuracy of the dissertation's LCI and LCA phases, the study's reliability is considered high. However, the study relies upon a single case study, and the generalizability is thus low, as discussed further when evaluating the validity of the dissertation results.

### *Reliability of policy implication results*

**PIII** presents an analysis of the LCA research findings' context to the current EU climate and energy policy. The nature of public policy and supporting legal acts such as regulations and directives is subject to interpretation. Furthermore, the complexity of these legal acts, their interconnectivity, as well as their reference to multiple supporting documents such as standards and reports make holistic policy analysis a complicated task. The complexity enables the possibility of different interpretations by different researchers or assessors studying a similar subject, reducing the reliability of the study's policy implication results.

Within this dissertation, a thorough review of the different policy documents was made as described in Section 2.2 and, in more detail, in **PIII**. Furthermore, publications on this study's focus areas, namely the GHG emissions and primary energy demand (or CED) of geothermal

and other energy systems, were reviewed and evaluated to compare with this study's methodology and findings. As an example, publications exist that show the different interpretations of researchers on how to calculate the PEF for electricity from geothermal resources, as seen in the compilation of PEF results in Table 3.

To conclude, the reliability of the study's policy implication results are evaluated as high, and that the policy implications are correctly stated within the dissertation. The conclusion is based on the thoroughness of the review and interpretation of the "Clean energy for all" package and all related documents that defined approaches to calculation procedures, especially for the primary energy demand and PEF.

## **5.2.2 Validity**

In terms of the validity of the research and its capability to answer the main research question, two main methodological implications on the overall study are discussed here; (i) the validity of a case study approach and (ii) the validity of LCA methodology to answer the overall research question in the study.

### *The validity of a case study approach*

The dissertation's analytical part is designed around a single case study, resulting in limitations of the study to reach a conclusive answer to the overall research question that can be generalized for the utilization of geothermal resources. Case studies have been criticized as a research strategy, i.e., due to their inherent lack of generalizability (Yin, 1981). However, case studies are considered a valid research strategy, and many researchers have strongly defended their application. They claim they are essential to theory building (Eisenhardt and Graebner, 2007), to systematically produce exemplars in scientific disciplines (Flyvbjerg, 2006), and to examine phenomena in their real-life contexts (Yin, 1981).

For high-temperature geothermal utilization, in particular, most attempts to reach general conclusions on certain topics are challenging. The design and impacts of geothermal power plants are very site-specific, related to the geothermal resource's natural characteristics. Geothermal resources have varying characteristics regarding energy production potential, chemical properties, and geological conditions (Tomasini-Montenegro et al., 2017, Bayer et al., 2013). This study shows how these characteristics contribute significantly to the potential environmental impacts studied within LCA. Attempts to generalize geothermal resources have led to the classification of resources into multiple sub-categories based on the different geophysical and geochemical characteristics (e.g., (Moeck, 2014)). This can lead to small selections of cases having the most similar characteristics due to the relatively few geothermal applications worldwide. However, the increase in the number of case studies will, case by case, deliver a range of results for the different environmental impacts in the field of LCA, making it possible to better locate geothermal energy utilization on the spectrum of LCA results compared to other energy technologies.

Furthermore, the scarcity of LCI data and LCA studies for high-temperature utilization made it ill-achievable within this study to make an overall comparison of the case study results to reach a general conclusion. In return, the dissertation achieves a more in-depth analysis and focused discussion on the potential life cycle environmental impacts and efficiency considerations for one of the largest, state-of-the-art, high-temperature geothermal power plants in the world. The study, therefore, gives a few pieces to the puzzle rather than providing a concluding answer to the main research question.

## *The validity of an LCA approach*

The methodology of life cycle assessment is not without criticism when it comes to scientific foundation and the reliability and validity of LCA results (Suh et al., 2004, Heijungs et al., 2019, Huijbregts, 1998, Curran, 2014, Heijungs et al., 2009). This section will discuss the extent to which the methodology of LCA achieves to answer the overall research question within this study.

The validity of using LCA to calculate the overall GHG emissions (in terms of GWP) and the primary energy demand (in terms of CED) is sound. These topics are the focus of two of the sub-research questions, **SQ1** and **SQ3**. LCA proves to be successful in analyzing the CED by collecting all the energy uses modeled within the product system's value chain. This holistic evaluation of energy use is, in fact, a requirement of the standards and definitions dealing with primary energy within EU legal acts (European Council Directive, 2018a, ISO, 2017, European committee for standardization, 2017b). Particularly when it comes to evaluating the non-renewable and renewable part of the primary energy factor, the CED method robustly assesses this breakdown of these energy flows. Therefore, using CED to analyze the primary energy demand and converting the results to the PEF for geothermal utilization is a valid methodology. Furthermore, assessing GHG emissions by calculating the GWP in LCA is a mature and well-recognized method to account for life cycle GHG emissions from energy technologies.

The results in this study, however, are based on a single case study as discussed above. Thus, the study does not give a generalizable answer to the research question. Nonetheless, a review of results is given in **PII** from other LCA studies on geothermal energy, showing that it can be claimed that emissions from geothermal utilization are an order of magnitude lower than from fossil energy technologies and in line with other renewable and low-carbon technologies. The results published in **PII** for the case study are shown to be in the lower margin of reported GHG emissions from such technologies, presenting an example of low-emitting high-temperature geothermal utilization.

Regarding other environmental impacts than the GWP and CED, **PII** highlights the H<sub>2</sub>S emissions from the case study as a hotspot compared to other energy technologies. Thus, the LCA approach highlights the potential adverse effects of choosing geothermal energy instead of other energy technologies, which was the focus of **SQ2**. However, the impact assessment method for acidification potential (AP) had to be manually modified for the effects of H<sub>2</sub>S to appear in the AP results. The H<sub>2</sub>S emissions also affected the human toxicity potential (HP) to some degree. Literature, however, states that known health effects of H<sub>2</sub>S in continuous low-concentrations, as is relevant in the vicinity of some geothermal power plants, are insufficient and non-conclusive (e.g. (Finnbjornsdottir et al., 2016, Finnbjornsdottir et al., 2015, Bates et al., 2015)). Thus, a conclusion can be drawn that the LCA methodology does not represent such emissions well within LCIA methods. The validity of the application of LCA methodology to assess the environmental effects of H<sub>2</sub>S emissions is thus found to be inadequate and in grave need of further development of a valid methodology of impact assessment.

**PII** also points out that some known impacts of the case study are not addressed in the LCA. The findings highlight that LCA cannot be used as a stand-alone method to evaluate all significant environmental impacts of technologies, projects, or products. It instead gives valuable insight into potential environmental impacts associated with other life cycle stages

than the classical evaluation of operational phase only, as well as serving as a basis for comparison of different technologies in a standardized way as stated above.

However, the use of LCA methodology achieves two things: First, providing an academically accepted methodology that follows international standards to allow for a comprehensive comparison of different technologies. Second, it highlights multiple categories of environmental impacts instead of focusing on a single impact at a time, making it possible to see rather robustly if a specific technology performing well in a specific impact category has adverse effects in other impact categories.

To conclude, the evaluation of the validity of the approaches and the answer to the overall research question can be stated as of sound scientific merit. The limitations are well explained and acknowledged throughout the study and claimed to be justifiable for the problem statement at hand.

### **5.3 Future research recommendations**

This dissertation is intended to answer specific questions regarding geothermal energy utilization and its compliance with current energy policy. Indeed, some issues are raised and left unanswered in this study and should be further explored to enhance understanding and contribute to further research on LCA for geothermal application and to strengthen the role of geothermal utilization in current climate and energy policy. This section raises these issues and suggests further research to investigate them further.

The scarcity of LCA studies is often mentioned and applies to many industries, including geothermal. Future research providing more LCA studies on geothermal projects would greatly benefit the field, especially on existing projects with construction and operational data available rather than modeling fictional cases. The primary purpose of publishing the detailed LCI compiled in **PI** within this study was to encourage and make available data for others to use to perform geothermal LCAs. The paper has already aided several studies using LCA as a tool, and the emerging popularity of the LCA as a trusted tool to evaluate environmental impacts is evident. The most recent example being a publication in *Nature Energy* utilizing the data from **PI** as input in LCA analysis of carbon capture technology that uses electricity from the Hellisheiði geothermal plant (Deutz and Bardow, 2021).

At least three current H2020 projects involve LCA of geothermal energy technology and partially build upon the outcome of this dissertation's publications. The GECO project (Geothermal Emission Control) focuses on the potential of the Carbfix CCS method to make geothermal projects cleaner by applying it to three new geothermal sites to reduce both H<sub>2</sub>S and CO<sub>2</sub> emissions. The project applies LCA to analyze the different project sites and the abatement technology and uses the LCI and LCA results for Hellisheiði as input (Colucci et al., 2021). The Geoenvi project is focused on the LCA analysis of deep geothermal utilization. One of the aims is to develop a simplified LCA methodology for geothermal projects for robust analysis. The study builds, amongst others, upon the LCI gathered in this dissertation and, along with other newly collected LCIs for geothermal projects, compiles an average dataset to be used in future studies of geothermal environmental impact assessment (Tosti et al., 2020, Parisi et al., 2020). The S4CE (Science for Clean Energy) project aims to identify risk mitigation methods for sub-surface operations in geothermal and other applications. One of the tasks is to analyze the environmental impacts of such sub-surface applications, and the

project has produced publications that rely on the outcomes of this dissertation (Paulillo et al., 2019, Paulillo et al., 2020b). Lastly, a report has recently been published by request of the EU on environmental impacts of deep geothermal projects in Europe, which bases on LCA studies with a special focus on air pollutant emissions (European Commission, 2020b). All these initiatives will add significantly to the field of LCA for geothermal utilization and make results available to put forward more generic conclusions on the life cycle impacts of different geothermal energy technologies.

Further development of how H<sub>2</sub>S emissions are translated into impacts on human health and the environment is essential in LCA methodology for geothermal applications. Here, in-situ analysis is crucial as the different concentration levels of H<sub>2</sub>S have different known impacts on both human health and the environment. However, the impact of inorganic chemicals in life cycle impact assessment is a very relevant topic in LCA (e.g., (Kirchhübel and Fantke, 2019)). Since H<sub>2</sub>S emissions are characteristic of geothermal applications and other specific industrial processes such as oil refining, wastewater treatments, and paper pulp manufacturing, it may require these industries to push forward or support research on the topic of LCIA of H<sub>2</sub>S.

Closely connected to the topic of this dissertation is LCA research on geothermal direct use applications. Although it was not a focus in this study, such research would continue to highlight the benefits and limitations of geothermal utilization in a broader perspective.

This dissertation furthermore contributes to defining the overall PEF of electricity within the Icelandic electricity grid. The PEF calculated within this study covers roughly 12% of the generated electricity in Iceland based on 2018 energy statistics (Orkustofnun, 2020a, Orkustofnun, 2020b). Further research on the actual PEF for other geothermal plants in Iceland, as well as applying a PEF of 1 to the hydropower produced in Iceland, would suffice to produce the actual overall PEF of the Icelandic electricity grid. Furthermore, projections could be made on the development of the PEF to 2030 and 2050 according to the projected changes in the electricity mix. Although Iceland has not implemented the EED nor the EPBD to this date, this would be valuable information to position Iceland amongst the EU countries and even prepare for potential implementation of these directives into Icelandic legislation.

# Conclusions

The dissertation presents and discusses the main findings of the study in the sections above. Here, the main learnings from the results of this dissertation are summarized:

- Life cycle GHG emissions from high-temperature geothermal utilization can be similar to other renewable energy technologies. Thus, geothermal utilization can contribute significantly, and equally as other renewables, to lowering GHG emissions associated with energy use by replacing fossil fuels in current and future energy systems.
- H<sub>2</sub>S emissions are a hotspot in the LCA for high-temperature geothermal utilization as the gas contributes to acidification and human toxicity potential. The impact assessment methods (LCIA) of atmospheric emissions of H<sub>2</sub>S need further research.
- Abatement methods exist to lower GHG and H<sub>2</sub>S emissions from geothermal applications, with the potential of reaching almost zero footprints for those two emissions. The study highlights the Carbfix and Sulfix method, developed at the Hellisheidi plant and has contributed to lowering the GHG emissions from the plant by 25-30% and H<sub>2</sub>S emissions by 75-80%. These methods have the potential to contribute to zero-footprint regarding these emissions.
- Due to the low thermal efficiency of electricity generation from geothermal, its increased use does not result in the desired increased energy efficiency when added or replacing older technologies in the current energy system. Thus, a barrier exists in current EU policy that may hinder geothermal energy from becoming one of the desired solutions to reach the 2030 climate and energy targets.

The dissertation's contribution as a whole is of practical and theoretical value in the fields of LCA, energy policy, and primary energy efficiency for geothermal applications, as discussed in Section 5.1. As performed in this dissertation, the detailed analysis of a case study provides means for further theory building on the application of geothermal resources to provide heat and power to future energy systems. An evident need is present for more case studies on geothermal applications using LCA methodology and policy perspectives in their analysis. Recent publications and current research initiatives within the field of geothermal and LCA, particularly in Europe, set out to further improve the application of LCA for geothermal technologies. Important efforts to merge published and ongoing case studies into generalizable models are being made, key geothermal characteristics in terms of environmental performance are being identified, new datasets are being made available, and industry guidelines being published on how to conduct such studies in the future for better consistency within the field. This study has proved to be one of the valuable contributions to this ongoing research.





## References

- Aradóttir, E. S. P., Gunnarsson, I., Sigfússon, B., Gunnarsson, G., Júlíusson, B. M., Gunnlaugsson, E., Sigurdardóttir, H., Arnarson, M. T. & Sonnenthal, E. 2015. Toward Cleaner Geothermal Energy Utilization: Capturing and Sequestering CO<sub>2</sub> and H<sub>2</sub>S Emissions from Geothermal Power Plants. *Transport in Porous Media*, 108, 61-84.
- Ármannsson, H., Fridriksson, T. & Kristjánsson, B. R. 2005. CO<sub>2</sub> emissions from geothermal power plants and natural geothermal activity in Iceland. *Geothermics*, 34, 286-296.
- Bare, J. C. 2014. Development of impact assessment methodologies for environmental sustainability. *Clean Technologies and Environmental Policy*, 16, 681-690.
- Bare, J. C., Hofstetter, P., Pennington, D. W. & De Haes, H. a. U. 2000. Midpoints versus endpoints: The sacrifices and benefits. *The International Journal of Life Cycle Assessment*, 5, 319.
- Bates, M. N., Crane, J., Balmes, J. R. & Garrett, N. 2015. Investigation of Hydrogen Sulfide Exposure and Lung Function, Asthma and Chronic Obstructive Pulmonary Disease in a Geothermal Area of New Zealand. *PLOS ONE*, 10, e0122062.
- Bayer, P., Rybach, L., Blum, P. & Brauchler, R. 2013. Review on life cycle environmental effects of geothermal power generation. *Renewable and Sustainable Energy Reviews*, 26, 446-463.
- Bertani, R. Geothermal power generation in the world 2010-2015 update report. World Geothermal Congress 2015, 19-25 April 2015 2015 Melbourne, Australia.
- Bertani, R. & Thain, I. 2002. Geothermal power generating plant CO<sub>2</sub> emission survey. *IGA news*.
- Bio Intelligence Service, Ronan Lyons & Ieep 2013. Energy performance certificates in buildings and their impact on transaction prices and rents in selected EU countries. Final report prepared for European Commission (DG Energy).
- Björklund, A. E. 2002. Survey of approaches to improve reliability in lca. *The International Journal of Life Cycle Assessment*, 7, 64.
- Bravi, M. & Basosi, R. 2014. Environmental impact of electricity from selected geothermal power plants in Italy. *Journal of Cleaner Production*, 66, 301-308.
- Buonocore, E., Vanoli, L., Carotenuto, A. & Ulgiati, S. 2015. Integrating life cycle assessment and emergy synthesis for the evaluation of a dry steam geothermal power plant in Italy. *Energy*, 86, 476-487.
- Cherubini, F. & Strømman, A. H. 2011. Life cycle assessment of bioenergy systems: State of the art and future challenges. *Bioresource Technology*, 102, 437-451.
- Colucci, V., Manfreda, G., Mendecka, B., Talluri, L. & Zuffi, C. 2021. LCA and Exergo-Environmental Evaluation of a Combined Heat and Power Double-Flash Geothermal Power Plant. *Sustainability*, 13, 1935.
- Creswell, J. W. & Miller, D. L. 2000. Determining validity in qualitative inquiry. *Theory into practice*, 39, 124-130.
- Curran, M. A. 2014. Strengths and Limitations of Life Cycle Assessment. In: KLÖPFFER, W. (ed.) *Background and Future Prospects in Life Cycle Assessment*. Dordrecht: Springer Netherlands.
- Curran, M. A., Mann, M. & Norris, G. 2005. The international workshop on electricity data for life cycle inventories. *Journal of Cleaner Production*, 13, 853-862.

- Delovato, N., Sundarnath, K., Cvijovic, L., Kota, K. & Kuravi, S. 2019. A review of heat recovery applications for solar and geothermal power plants. *Renewable and Sustainable Energy Reviews*, 114, 109329.
- Deutz, S. & Bardow, A. 2021. Life-cycle assessment of an industrial direct air capture process based on temperature–vacuum swing adsorption. *Nature Energy*, 6, 203-213.
- Dipippo, R. 2008. *Geothermal Power Plants. Principles, Applications, Case Studies and Environmental Impact*, Elsevier.
- Directorate-General for Energy 2019. Clean energy for all Europeans. Publication Office of the European Union.
- Eberle, A., Heath, G. A., Carpenter Petri, A. C. & Nicholson, S. R. 2017. Systematic Review of Life Cycle Greenhouse Gas Emissions from Geothermal Electricity. United States.
- EC-JRC 2011. International Reference Life Cycle Data System (ILCD) Handbook: Analysing of Existing Environmental Impact Assessment Methodologies for Use in Life Cycle Assessment (first edition). *In: EUROPEAN COMMISSION (ED.) (ed.)*.
- Eisenhardt, K. M. & Graebner, M. E. 2007. Theory Building From Cases: Opportunities And Challenges. *Academy of Management Journal*, 50, 25-32.
- EN 15603:2008 2008. Energy performance of buildings - Overall energy use and definition of energy ratings. Brussels: European Committee for Standardization (CEN).
- EPD International 2020. Product Category Rules (PCR). Electricity, steam and hot water generation and distribution 4ed.
- European Commission 2013. 2013/179/EU: Commission Recommendation of 9 April 2013 on the use of common methods to measure and communicate the life cycle environmental performance of products and organisations. Brussels: EUR-Lex.
- European Commission 2014. Communication from the Commission to the European Parliament, the Council, the European Economic and Social Committee and the Committee of the Regions. A policy framework for climate and energy in the period from 2020 to 2030. Brussels.
- European Commission. 2016a. *2030 climate & energy framework* [Online]. Available: Available online: [https://ec.europa.eu/clima/policies/strategies/2030\\_en](https://ec.europa.eu/clima/policies/strategies/2030_en) [Accessed accessed on 21 November 2019 2019].
- European Commission. 2016b. *Paris Agreement* [Online]. Available: [https://ec.europa.eu/clima/policies/international/negotiations/paris\\_en](https://ec.europa.eu/clima/policies/international/negotiations/paris_en) [Accessed January 10 2021].
- European Commission. 2017. *Clean energy for all Europeans package* [Online]. Available: Available online: <https://ec.europa.eu/energy/en/topics/energy-strategy-and-energy-union/clean-energy-all-europeans> [Accessed accessed on 21 November 2019 2019].
- European Commission. 2019. *The European Green Deal* [Online]. Available: Available online: [https://ec.europa.eu/commission/presscorner/detail/e%20n/ip\\_19\\_6691](https://ec.europa.eu/commission/presscorner/detail/e%20n/ip_19_6691) [Accessed accessed on 17 April 2020 2020].
- European Commission 2020a. State of the Union: Commission raises climate ambition and proposes 55% cut in emissions by 2030. Brussels.
- European Commission 2020b. Study on ‘Geothermal plants’ and applications’ emissions. Brussels.
- European Committee for Standardization 2017a. EN 15316-4-5:2017 (E). Heating systems in buildings - Method for calculation of system energy requirements and system efficiencies - Part 4-5: District heating and cooling.
- European Committee for Standardization 2017b. Energy performance of buildings - Overarching EPB assessment - Part 2: Explanation and justification of ISO 52000-1 (CEN ISO/TR 52000-2:2017).

- European Council Directive 2010/31/EU. Directive 2010/31/EU of the European Parliament and of the Council of 19 May 2010 on the energy performance of buildings, OJ L 315, 14.11.2012.
- European Council Directive 2018a. Directive (EU) 2018/844 of the European Parliament and of the Council of 30 May 2018 amending Directive 2010/31/EU on the energy performance of buildings and Directive 2012/27/EU on energy efficiency (Text with EEA relevance). Official Journal of the European Union.
- European Council Directive 2018b. Directive (EU) 2018/2002 of the European Parliament and of the Council of 11 December 2018 amending Directive 2012/27/EU on energy efficiency. Official journal of the European Union.
- European Council Directive 2018c. Directive (EU) 2018/2002 of the European Parliament and of the Council of 11 December 2018 on the promotion of the use of energy from renewable sources (recast) Official journal of the European Union.
- Eurostat 2019. Energy balance guide. Methodology guide for the construction of energy balances & Operational guide for the energy balance builder tool.
- Eurostat. 2020a. *Renewable energy statistics* [Online]. Available: [https://ec.europa.eu/eurostat/statistics-explained/index.php?title=Renewable\\_energy\\_statistics](https://ec.europa.eu/eurostat/statistics-explained/index.php?title=Renewable_energy_statistics) [Accessed January 10 2021].
- Eurostat. 2020b. *Statistics Explained. Energy saving statistics*. [Online]. Available: [https://ec.europa.eu/eurostat/statistics-explained/index.php/Energy\\_saving\\_statistics#:~:text=Energy%20efficiency%20targets%20for%202020%20and%202030&text=In%20other%20words%2C%20the%20EU,is%20at%20least%2032.5%20%25%20reduction.](https://ec.europa.eu/eurostat/statistics-explained/index.php/Energy_saving_statistics#:~:text=Energy%20efficiency%20targets%20for%202020%20and%202030&text=In%20other%20words%2C%20the%20EU,is%20at%20least%2032.5%20%25%20reduction.) [Accessed 16 January 2021].
- Finnbjornsdottir, R. G., Carlsen, H. K., Thorsteinsson, T., Oudin, A., Lund, S. H., Gislason, T. & Rafnsson, V. 2016. Association between Daily Hydrogen Sulfide Exposure and Incidence of Emergency Hospital Visits: A Population-Based Study. *PLOS ONE*, 11, e0154946.
- Finnbjornsdottir, R. G., Oudin, A., Elvarsson, B. T., Gislason, T. & Rafnsson, V. 2015. Hydrogen sulfide and traffic-related air pollutants in association with increased mortality: a case-crossover study in Reykjavik, Iceland. *BMJ Open*, 5.
- Flyvbjerg, B. 2006. Five Misunderstandings about Case-Study Research Available at SSRN: <https://ssrn.com/abstract=2230464>. *Qualitative Inquiry*, vol. 12, pp. 219-245.
- Fraunhofer-Institut Für System- Und Innovationsforschung (Isi) 2016. Evaluation of primary energy factor calculation options for electricity. Germany.
- Frick, S., Kaltschmitt, M. & Schroder, G. 2010. Life cycle assessment of geothermal binary power plants using enhanced low-temperature reservoirs. *Energy*, 35, 2281-2294.
- Fridriksson, T., Mateos, A., Orucu, Y. & Audinet, P. 2017. Greenhouse Gas Emissions from Geothermal Power Production. *Stanford Geothermal Workshop*. Stanford, California.
- Fröling, M., Holmgren, C. & Svanström, M. 2004. Life cycle assessment of the district heat distribution system. *The International Journal of Life Cycle Assessment*, 9, 130-136.
- Fröling, M. & Svanström, M. 2005. Life Cycle Assessment of the District Heat Distribution System - Part 2: Network Construction (11 pp). *The International Journal of Life Cycle Assessment*, 10, 425-435.
- Golafshani, N. 2003. Understanding reliability and validity in qualitative research. *The qualitative report*, 8, 597-607.
- Guðjónsdóttir, S. R., Eggertsson, V., Guðmundsdóttir, M. & Jóhannesson, G. A. 2020. Panorama of available environmental assessment studies and sustainability assessment studies for geothermal systems.

- Guinée, J. B., Heijungs, R., Huppes, G., Zamagni, A., Masoni, P., Buonamici, R., Ekvall, T. & Rydberg, T. 2011. Life cycle assessment: Past, present, and future. *Environmental Science and Technology*, 45, 90-96.
- Guinée, J. B. G., M.; Heijungs, R.; Huppes, G.; Kleijn, R.; Koning, A. De; Oers, L. Van; Wegener Sleeswijk, A.; Suh, S.; Udo De Haes, H.A.; Bruijn, H. De; Duin, R. Van; Huijbregts, M.A.J. 2002. *Handbook on life cycle assessment. Operational guide to the ISO standards. I: LCA in perspective. Iia: Guide. Iib: Operational annex. III: Scientific background.*, Dordrecht, Kluwer Academic Publishers.
- Gunnarsson, I., Aradóttir, E. S., Oelkers, E. H., Clark, D. E., Arnarson, M. Þ., Sigfússon, B., Snæbjörnsdóttir, S. Ó., Matter, J. M., Stute, M., Júlíusson, B. M. & Gíslason, S. R. 2018. The rapid and cost-effective capture and subsurface mineral storage of carbon and sulfur at the CarbFix2 site. *International Journal of Greenhouse Gas Control*, 79, 117-126.
- Gunnarsson, I., Aradóttir, E. S., Sigfússon, B., Gunnlaugsson, E., Júlíusson, B. M. & Energy, R. 2013. Geothermal gas emission from Hellisheiði and Nesjavellir power plants, Iceland. *GRC Transactions*, 37, 7859.
- Hanbury, O. & Vasquez, V. R. 2018. Life cycle analysis of geothermal energy for power and transportation: A stochastic approach. *Renewable Energy*, 115, 371-381.
- Heijungs, R., Guinée, J. B., Mendoza Beltrán, A., Henriksson, P. J. G. & Groen, E. 2019. Everything is relative and nothing is certain. Toward a theory and practice of comparative probabilistic LCA. *The International Journal of Life Cycle Assessment*, 24, 1573-1579.
- Heijungs, R. & Huijbregts, M. a. J. 2004. A review of approaches to treat uncertainty in LCA. *International Congress on Environmental Modelling and Software*. Osnabrück, Germany.
- Heijungs, R., Huppes, G. & Guinée, J. 2009. A scientific framework for LCA, deliverable (D15) of work package 2 (WP2) CALCAS project. *Institute of Environmental Sciences, Leiden University (CML)*.
- Heinonen, J., Laine, J., Pluuman, K., Säynäjoki, E.-S., Soukka, R. & Junnila, S. 2015. Planning for a Low Carbon Future? Comparing Heat Pumps and Cogeneration as the Energy System Options for a New Residential Area. *Energies*, 8, 9137.
- Hellweg, S. & I Canals, L. M. 2014. Emerging approaches, challenges and opportunities in life cycle assessment. *Science*, 344, 1109-1113.
- Hertwich, E. G. & Wood, R. 2018. The growing importance of scope 3 greenhouse gas emissions from industry. *Environmental Research Letters*, 13, 104013.
- Hischier R., W. B., Althaus H.-J., Bauer C., Doka G., Dones R., Frischknecht R., Hellweg S., H. S., Jungbluth N., Köllner T., Loerincik Y., Margni M. And & T., N. 2010. Implementation of Life Cycle Impact Assessment Methods.ecoinvent report No. 3, v2.2. Dübendorf.
- Hitchin, R. 2018. Primary Energy Factors and the primary energy intensity of delivered energy: An overview of possible calculation conventions. *Building Services Engineering Research and Technology*, 40, 014362441879971.
- Holmberg, H., Tuomaala, M., Haikonen, T. & Ahtila, P. 2012. Allocation of fuel costs and CO<sub>2</sub>-emissions to heat and power in an industrial CHP plant: Case integrated pulp and paper mill. *Applied Energy*, 93, 614-623.
- Hondo, H. 2005. Life cycle GHG emission analysis of power generation systems: Japanese case. *Energy*, 30, 2042-2056.
- Huijbregts, M. a. J. 1998. Application of uncertainty and variability in LCA. *The International Journal of Life Cycle Assessment*, 3, 273.

- Huijbregts, M. a. J., Steinmann, Z. J. N., Elshout, P. M. F., Stam, G., Verones, F., Vieira, M., Zijp, M., Hollander, A. & Van Zelm, R. 2017. ReCiPe2016: a harmonised life cycle impact assessment method at midpoint and endpoint level. *The International Journal of Life Cycle Assessment*, 22, 138-147.
- Huttrer, G. W. 2020. Geothermal Power Generation in the World 2015-2020 Update Report. *World Geothermal Congress*. Reykjavik, Iceland.
- IAEG-SDGs 2017. Global indicator framework for the Sustainable Development Goals and targets of the 2030 Agenda for Sustainable Development E/CN.3/2020/2 ed.
- Iceland Environmental Agency 2020. National Inventory Report - Emissions of greenhouse gases in Iceland from 1990 to 2018. Reykjavík, Iceland.
- IEA. 2017. *Commentary: Understanding and using the Energy Balance* [Online]. Available: Available online: [https://www.iea.org/newsroom/news/2017/september/commentary-understanding-and-using-the-energy-balance.html?utm\\_content=buffer3537d](https://www.iea.org/newsroom/news/2017/september/commentary-understanding-and-using-the-energy-balance.html?utm_content=buffer3537d) [Accessed accessed on 26 November 2019 2019].
- IINAS 2014. GEMIS global emissions model for integrated systems. *In: IINAS (ed.) version 4.9 ed.* Internet release.
- IINAS 2015. Development of the Primary Energy Factor of Electricity Generation in the EU-28 from 2010-2013. Darmstadt, Germany: International Institute for Sustainability Analysis and Strategy (IINAS).
- IRENA. 2020. *Bioenergy* [Online]. Available: <https://www.irena.org/bioenergy> [Accessed January 10 2021].
- Islam, M. M. & Hasanuzzaman, M. 2020. Chapter 1 - Introduction to energy and sustainable development. *In: HASANUZZAMAN, M. D. & RAHIM, N. A. (eds.) Energy for Sustainable Development*. Academic Press.
- ISO 2006a. Environmental management - Life cycle assessment - Requirements and guidelines (ISO 14044:2006). Switzerland: ISO - International Organization for Standardization.
- ISO 2006b. Environmental management - Life cycle assessment -Principles and framework (ISO 14040:2006). Switzerland: ISO - International Organization for Standardization.
- ISO 2017. Energy performance of buildings - Overarching EPB assessment - Part 1: General framework and procedures (ISO 52000-1:2017). International Organization for Standardization,.
- Jolliet, O., Margni, M., Charles, R., Humbert, S., Payet, J., Rebitzer, G. & Rosenbaum, R. 2003. IMPACT 2002+: A new life cycle impact assessment methodology. *The International Journal of Life Cycle Assessment*, 8, 324.
- Juncu, D., Árnadóttir, T., Geirsson, H., Guðmundsson, G. B., Lund, B., Gunnarsson, G., Hooper, A., Hreinsdóttir, S. & Michalczewska, K. 2018. Injection-induced surface deformation and seismicity at the Hellisheidi geothermal field, Iceland. *Journal of Volcanology and Geothermal Research*.
- Karlsdóttir, M. R., Heinonen, J., Pálsson, H. & Pálsson, O. P. 2020a. High-Temperature Geothermal Utilization in the Context of European Energy Policy—Implications and Limitations. *Energies*, 13, 3187.
- Karlsdóttir, M. R., Heinonen, J., Pálsson, H. & Pálsson, O. P. 2020b. Life cycle assessment of a geothermal combined heat and power plant based on high temperature utilization. *Geothermics*, 84, 101727.
- Karlsdóttir, M. R., Lew, J. B., Pálsson, H. & Pálsson, O. P. 2014. Geothermal district heating system in Iceland: A life cycle perspective with focus on primary energy efficiency and CO2 emissions. *Th 14th International Symposium on District Heating and Cooling*. Stockholm, Sweden.

- Karlsdóttir, M. R., Palsson, H. & Palsson, O. P. Factors for Primary Energy Efficiency and CO<sub>2</sub> Emission of Geothermal Power Production. World Geothermal Congress 2010, 25-29 April 2010a Bali, Indonesia.
- Karlsdóttir, M. R., Palsson, H. & Palsson, O. P. LCA of combined heat and power production at Hellisheidi geothermal power plant with focus on primary energy efficiency. 12th International Symposium on District Heating and Cooling, September 2010b Tallinn, Estonia.
- Karlsdóttir, M. R., Palsson, H., Palsson, O. P. & Maya-Drysdale, L. 2015. Life cycle inventory of a flash geothermal combined heat and power plant located in Iceland. *The International Journal of Life Cycle Assessment*, 1-17.
- Kirchhübel, N. & Fantke, P. 2019. Getting the chemicals right: Toward characterizing toxicity and ecotoxicity impacts of inorganic substances. *Journal of Cleaner Production*, 227, 554-565.
- Klöppfer, W. 1997. Life cycle assessment. *Environmental Science and Pollution Research*, 4, 223-228.
- Klöppfer, W. & Curran, M. A. 2014. How many case studies should we publish, if any? *The International Journal of Life Cycle Assessment*, 19, 1-2.
- Kristmannsdóttir, H. & Ármannsson, H. 2003. Environmental aspects of geothermal energy utilization. *Geothermics*, 32, 451-461.
- Lund, J. W. & Chiasson, A. 2007. Examples of combined heat and power plants using geothermal energy. *European Geothermal Congress (EGC)*. Unterhaching, Germany.
- Lund, J. W. & Toth, A. N. 2020. Direct Utilization of Geothermal Energy 2020 Worldwide Review. *World Geothermal Congress*. Reykjavik, Iceland.
- Manzella, A., Bonciani, R., Allansdóttir, A., Botteghi, S., Donato, A., Giamberini, S., Lenzi, A., Paci, M., Pellizzone, A. & Scrocca, D. 2018. Environmental and social aspects of geothermal energy in Italy. *Geothermics*, 72, 232-248.
- Marchand, M., Blanc, I., Marquand, A., Beylot, A., Bezelgues-Courtade, S. & Traineau, H. Life Cycle Assessment of High Temperature Geothermal Energy Systems. World Geothermal Congress 2015, 2015 Melbourne, Australia.
- Marieni, C., Prikryl, J., Aradóttir, E. S., Gunnarsson, I. & Stefánsson, A. 2018. Towards 'green' geothermal energy: Co-mineralization of carbon and sulfur in geothermal reservoirs. *International Journal of Greenhouse Gas Control*, 77, 96-105.
- Martinez-Corona, J. I., Gibon, T., Hertwich, E. G. & Parra-Saldivar, R. 2017. Hybrid life cycle assessment of a geothermal plant: From physical to monetary inventory accounting. *Journal of Cleaner Production*, 142, 2509-2523.
- Moeck, I. S. 2014. Catalog of geothermal play types based on geologic controls. *Renewable and Sustainable Energy Reviews*, 37, 867-882.
- Moomaw, W., Burgherr, P., Heath, G., Lenzen, M., Nyboer, J. & Verbruggen, A. 2011. Annex II: Methodology. In IPCC Special Report on Renewable Energy Sources and Climate Change Mitigation. Cambridge, United Kingdom and New York, NY, USA.
- Moretti, C., Corona, B., Rühlin, V., Götz, T., Junginger, M., Brunner, T., Oberberger, I. & Shen, L. 2020. Combining Biomass Gasification and Solid Oxid Fuel Cell for Heat and Power Generation: An Early-Stage Life Cycle Assessment. *Energies*, 13, 2773.
- Morse, J. M., Barrett, M., Mayan, M., Olson, K. & Spiers, J. 2002. Verification strategies for establishing reliability and validity in qualitative research. *International journal of qualitative methods*, 1, 13-22.
- Mutia, T. M., Fridriksson, T. & Jónsdóttir, I. S. 2016. Concentrations of sulphur and trace elements in semi-arid soils and plants in relation to geothermal power plants at Olkaria, Kenya. *Geothermics*, 61, 149-159.

- Neirotti, F., Noussan, M. & Simonetti, M. 2020. Evaluating the Emissions of the Heat Supplied by District Heating Networks through A Life Cycle Perspective. *Clean Technologies*, 2, 392-405.
- Niyazi, A., Gok, O. S., Mutlu, H. & Kılınc, G. CO2 Emission from Geothermal Power Plants in Turkey. World Geothermal Congress, 19-25 April 2015 Melbourne, Australia.
- Orkustofnun 2020a. OS-2019-T015-01: Development of electricity production in Iceland (2018). In: ORKUSTOFNUN (ed.). Iceland.
- Orkustofnun 2020b. OS-2020-T006-01: Installed Electrical Capacity and Electricity Generation of Geothermal Power Plants in Iceland 1969-2019. In: ORKUSTOFNUN (ed.). Iceland.
- Óladóttir, A. A. & Friðriksson, Þ. The evolution of CO2 emissions and heat flow through soil since 2004 in the Utilized Reykjanes Geothermal Area, SW Iceland: ten years of observations on changes in geothermal surface activity. 2015.
- Parisi, M. L., Douzief, M., Tosti, L., Pérez-López, P., Mendecka, B., Ulgiati, S., Fiaschi, D., Manfreda, G. & Blanc, I. 2020. Definition of LCA Guidelines in the Geothermal Sector to Enhance Result Comparability. *Energies*, 13, 3534.
- Parisi, M. L., Ferrara, N., Torsello, L. & Basosi, R. 2019. Life cycle assessment of atmospheric emission profiles of the Italian geothermal power plants. *Journal of Cleaner Production*, 234, 881-894.
- Paulillo, A., Cotton, L., Law, R., Striolo, A. & Lettieri, P. 2020a. Geothermal energy in the UK: The life-cycle environmental impacts of electricity production from the United Downs Deep Geothermal Power project. *Journal of Cleaner Production*, 249, 119410.
- Paulillo, A., Cotton, L., Law, R., Striolo, A. & Lettieri, P. 2020b. Life-cycle inventory data and impacts on electricity production at the United Downs Deep Geothermal Power project in the UK. *Data in Brief*, 29, 105117.
- Paulillo, A., Striolo, A. & Lettieri, P. 2019. The environmental impacts and the carbon intensity of geothermal energy: A case study on the Hellisheiði plant. *Environment International*, 133, 105226.
- Persson, C., Fröling, M. & Svanström, M. 2006. Life Cycle Assessment of the District Heat Distribution System. Part 3: Use Phase and Overall Discussion (10 pp). *The International Journal of Life Cycle Assessment*, 11, 437-446.
- Ridder, H.-G. 2017. The theory contribution of case study research designs. *Business Research*, 10, 281-305.
- Ritchie, H. 2017. Renewable energy. Published online at OurWorldInData.org.
- Rybach, L. 2003. Geothermal energy: sustainability and the environment. *Geothermics*, 32, 463-470.
- Ryberg, M., Vieira, M. D., Zgola, M., Bare, J. & Rosenbaum, R. K. 2014. Updated US and Canadian normalization factors for TRACI 2.1. *Clean Technologies and Environmental Policy*, 16, 329-339.
- Saemundsson, K., Axelsson, G. & Steingrímsson, B. 2009. Geothermal Systems in Global Perspective. Reykjavik, Iceland: ISOR – Iceland GeoSurvey
- Skone, T. J., Littlefield, J., Eckard, R., Cooney, G. & Marriott, J. 2012. Role of Alternative Energy Sources: Geothermal Technology Assessment U.S. National Energy Technology Laboratory.
- Soimakallio, S., Kiviluoma, J. & Saikku, L. 2011. The complexity and challenges of determining GHG (greenhouse gas) emissions from grid electricity consumption and conservation in LCA (life cycle assessment)—A methodological review. *Energy*, 36, 6705–6713.

- Suh, S., Lenzen, M., Treloar, G. J., Hondo, H., Horvath, A., Huppes, G., Jolliet, O., Klann, U., Krewitt, W., Moriguchi, Y., Munksgaard, J. & Norris, G. 2004. System Boundary Selection in Life-Cycle Inventories Using Hybrid Approaches. *Environmental Science & Technology*, 38, 657-664.
- Sullivan, J. L., Stephens, T. & Wang, M. 2014. Geothermal Power Production: Alternative Scenarios and Critical Issues. United States: Argonne National Lab. (ANL).
- Sullivan, J. L. & Wang, M. Q. 2013. Life cycle greenhouse gas emissions from geothermal electricity production. *Journal of Renewable and Sustainable Energy*, 5.
- Tomasini-Montenegro, C., Santoyo-Castelazo, E., Gujba, H., Romero, R. J. & Santoyo, E. 2017. Life cycle assessment of geothermal power generation technologies: An updated review. *Applied Thermal Engineering*, 114, 1119-1136.
- Tosti, L., Ferrara, N., Basosi, R. & Parisi, M. L. 2020. Complete Data Inventory of a Geothermal Power Plant for Robust Cradle-to-Grave Life Cycle Assessment Results. *Energies*, 13, 2839.
- Treyer, K. & Bauer, C. 2013. Life cycle inventories of electricity generation and power supply in version 3 of the ecoinvent database—part I: electricity generation. *The International Journal of Life Cycle Assessment*, 1-19.
- Turconi, R., Boldrin, A. & Astrup, T. 2013. Life cycle assessment (LCA) of electricity generation technologies: Overview, comparability and limitations. *Renewable and Sustainable Energy Reviews*, 28, 555-565.
- UNFCCC 2016. Report of the Conference of the Parties on its twenty-first session, held in Paris from 30 November to 13 December 2015. United Nations Framework Convention on Climate Change.
- United Nations 2015. Transforming our world: The 2030 agenda for sustainable development.
- United Nations. n.d. *Key aspects of the Paris Agreement* [Online]. Available: <https://cop23.unfccc.int/process-and-meetings/the-paris-agreement/the-paris-agreement/key-aspects-of-the-paris-agreement> [Accessed January 10 2021].
- Wang, Y., Du, Y., Wang, J., Zhao, J., Deng, S. & Yin, H. 2020. Comparative life cycle assessment of geothermal power generation systems in China. *Resources, Conservation and Recycling*, 155, 104670.
- Werner, S. 2017. International review of district heating and cooling. *Energy*, 137, 617-631.
- Yin, R. K. 1981. The Case Study Crisis: Some Answers. *Administrative Science Quarterly*, 26, 58-65.
- Zheng, M., Fang, R. & Yu, Z. 2016. Life Cycle Assessment of Residential Heating Systems: A Comparison of Distributed and Centralized Systems. *Energy Procedia*, 104, 287-292.



# Contributing papers



# Paper I

Karlsdottir, M. R., Palsson, H., Palsson, O. P. & Maya-Drysdale, L. (2015). Life cycle inventory of a flash geothermal combined heat and power plant located in Iceland. *The International Journal of Life Cycle Assessment*, 1-17.



# Life cycle inventory of a flash geothermal combined heat and power plant located in Iceland

Marta Rós Karlsdóttir · Ólafur Pétur Pálsson ·  
Halldór Pálsson · Larisa Maya-Drysdale

Received: 14 January 2014 / Accepted: 23 December 2014 / Published online: 22 January 2015  
© Springer-Verlag Berlin Heidelberg 2015

## Abstract

**Purpose** This paper presents a life cycle inventory (LCI) describing the material and energy demands for constructing and operating a geothermal combined heat and power (GCHP) plant as well as direct emissions of gases, waste water, and waste heat. The data are based on a newly constructed GCHP plant in Iceland, representing the design of both single flash (SF) and double flash (DF) power plants that currently produce the majority of electricity from geothermal plants worldwide.

**Methods** Primary data were collected for the construction, operation, and maintenance of a GCHP plant. As the design and operation of geothermal flash power plants is site-specific due to the different nature of geothermal resources, a method of scaling data to a site specific parameter is proposed to make the LCI available as representative secondary data for such plants. These parameters along with other data identified as site-specific serve as the minimum data to be collected for adjusting the presented data to represent other flash power plants with or without combined heat production.

**Results** The construction stage dominates the material burdens for the electricity and heat production. For the life cycle of electricity, it includes 80 % of diesel fuel use (whereof 96 % originates from well drilling), while 99 % of groundwater is used during the operational stage. The use and composition of geothermal fluid is site-specific but accounts for all direct

emissions from the electricity production. The main materials in terms of mass used for the construction of the GCHP plant are water, diesel, steel, cement, asphalt, bentonite, and silica flour. Mineral wool and aluminum were also among the main material contributors. Material and energy burdens per functional unit are generally higher for a SF plant compared with DF plants. For heat production, 1.7 MJ of waste heat from power generation is used to produce 1 MJ of usable heat.

**Conclusions** By presenting LCI data scaled with site-specific parameters, the flexibility of its use is increased as secondary data. However, the collection of primary data for the composition of geothermal fluid and values for site specific parameters is always required to represent local conditions. Thus, the LCI for Hellisheiði GCHP can be regarded as representative data for electricity and heat from geothermal flash power plants.

**Keywords** Combined heat and power (CHP) · Double flash · Electricity production · Geothermal energy · Heat production · Life cycle inventory (LCI) · Single flash

## Nomenclature

<i>CT</i>	Cooling tower
<i>CW</i>	Cold water well
<i>CWP</i>	Cold water pump
<i>CWT</i>	Cold water tank
<i>DA</i>	Deairator
<i>DHXX</i>	Heat exchanger for district heating water
<i>DHT</i>	District heating water tank
<i>FV</i>	Throttle valve
<i>GW</i>	Geothermal well
<i>HPC</i>	High-pressure condenser
<i>HPM</i>	High-pressure moisture remover
<i>HPS</i>	High-pressure steam separator
<i>HPTG</i>	High-pressure turbine-generator set
<i>HWP</i>	Hot water pump

Responsible editor: Rolf Frischknecht

M. R. Karlsdóttir (✉) · Ó. P. Pálsson · H. Pálsson  
School of Engineering and Natural Sciences, Department of  
Industrial Engineering, Mechanical Engineering and Computer  
Science, University of Iceland, VR-II, Hjardarhagi 2-6,  
107 Reykjavik, Iceland  
e-mail: mrk1@hi.is

L. Maya-Drysdale  
FORCE Technology, Park Allé 345, 2605 Brøndby, Denmark

<i>LPC</i>	Low-pressure condenser
<i>LPM</i>	Low-pressure moisture remover
<i>LPS</i>	Low-pressure steam separator
<i>LPTG</i>	Low-pressure turbine-generator set
<i>RW</i>	Reinjection well
<i>WE</i>	Wellhead equipment
<i>WS</i>	Well silencer

## 1 Introduction

The popularity of using Life Cycle Assessment (LCA) as a tool to evaluate the environmental impacts of products, processes, and services throughout their entire life cycle is steadily increasing. One of the key issues in many LCA studies is the use of energy. In order to correctly represent all the intrinsic environmental impacts associated with the use of energy in a product system, life cycle data on different energy production systems have to be accessible. Thus, Life Cycle Inventories (LCI) on these systems are an important input when performing LCAs, as emphasized during an international workshop on electricity data for life cycle inventories in 2001 (Curran et al. 2005).

Recent energy development projects in Iceland have made it one of the fastest growing countries with respect to geothermal power capacity (Bertani 2012) and the leading country in annual geothermal energy use for district heating (Lund et al. 2011). Due to the extensive use of geothermal energy in Iceland, access to published LCI data for geothermal electricity and heat is vital for future LCAs for Icelandic conditions, both at household and industry level.

Geothermal power plants can be classified into two types, based on whether they use geothermal fluid directly or indirectly to produce electricity. Plants that use geothermal fluid directly are either dry or flash steam power plants, depending on whether the geothermal wells deliver dry steam to the surface or a mixture of steam and water. Furthermore, flash steam power plants can be divided into single flash (SF) and double flash (DF) (or even triple flash) cycles. Multiple flash plants have the advantage over SF plants that they can utilize the liquid from the geothermal wells to produce more electricity by “flashing,” or boiling the liquid at a lower pressure, to produce more steam. Binary power plants use the geothermal fluid indirectly to boil a secondary fluid, producing steam for power production. Generally, binary power plants are more suitable to utilize geothermal fluid from low-temperature geothermal areas where dry and flash steam power plants utilize geothermal fluid from high-temperature geothermal areas (DiPippo 2008).

In a review by Bayer et al. (2013), an overview of published LCA studies on geothermal power plants is given.

Several of the studies mentioned there present LCI datasets for the life cycles of the energy conversion systems. A LCA study by Frick et al. (2010) focuses on theoretical case studies of binary cycle power plants that produce electricity and heat from low-temperature enhanced geothermal systems (EGS). A US report by Sullivan et al. (2010) presents LCI and LCA results for two types of EGS power plants as well as for binary and flash power plants. The study is largely based on model generated data and theoretical designs of the energy conversion cycles to develop the LCIs. A report from New Zealand, not included in Bayer et al. (2013), presents a carbon footprint and a detailed LCI for a proposed double flash geothermal power plant located in the Taupo region (Drysdale 2010). Finally, the ecoinvent v3 database provides datasets for electricity production from geothermal energy resources (ecoinvent Centre 2013), largely based on an EGS binary cycle power plant located in Basel, Switzerland (Treyer and Bauer 2013), which is currently not in operation (Giardini 2009).

Despite the abovementioned examples, the availability of published good-quality life cycle inventory data for geothermal energy production systems is scarce. Large focus is placed on developing LCIs for EGS and binary power plants, but EGS is an emerging technology not widely used in today’s geothermal energy utilization scenario and electricity from binary power plants only accounts for 9 % of the total produced electricity from geothermal resources worldwide (Bertani 2012). However, flash power plants, either single or double flash, account for 63 % of the worldwide produced electricity from geothermal resources (Bertani 2012) and 98.5 % of the installed geothermal electric capacity in Iceland.

The purpose of this study is to provide a detailed set of LCI primary data, representative for geothermal energy generation in Iceland, which can also be used as reference for other LCA studies of geothermal energy generation from both single and double flash power plants. The selected case, Hellisheiði geothermal combined heat and power plant (GCHP), is a flash power plant located in the high-temperature geothermal area of Hengill, in southwest Iceland. Due to the recent construction of the power plant<sup>1</sup>, large amount of data was readily available from the power company and engineering consultancies for the compilation of inventory data. The 303.3 MW installed capacity of Hellisheiði GCHP accounts for 46 % of the total electric capacity of geothermal power plants in Iceland. By providing a comprehensive LCI dataset for Hellisheiði GCHP, the results can also be used by LCA practitioners as reference values for the production of electricity and heat from high-temperature geothermal resources using similar technology. However, the data will have to be adjusted to individual power plants in question by collecting site-specific data identified in this study.

<sup>1</sup> The plant started its operation in 2006.

## 2 LCI methodology

In the following subsections, the documentation of the collection of LCI for Hellisheiði GCHP is based on the requirements and recommendations of ISO 14040 and 14044 (ISO 2006a, b).

### 2.1 Goal of the study

This study was carried out to produce a life cycle inventory dataset on the life cycle of a GCHP plant using flash technology (both single and double flash), based on primary data representing Icelandic conditions. A secondary goal of the study was to identify site specific parameters, of which values can be collected by LCA practitioners and used for scaling of the inventory data presented here. Thus, the LCI data presented in this study is available as secondary data for future LCA studies on flash power plants, with or without combined heat production.

The LCI presented is collected for attributional LCA studies, which has been forecasted to represent the material and energy flows for 30 years of plant operation. The 30 years' time is chosen for comparability with other datasets as it is a typical life time used. However, the service life of infrastructure and buildings as well as the geothermal reservoir itself can exceed that time, as has been experienced in Iceland<sup>2</sup>. Construction and operational data for the Hellisheiði GCHP plant were collected from primary data, and the operation of 30 years in the future is assumed to resemble operating conditions in the period of 2012 for power production and 2013 for heat production<sup>3</sup>. The inventory is presented in the form of product flows, with the exception of some elementary flows during the operational stage.

### 2.2 Scope of the study

#### 2.2.1 Product system—the Hellisheiði geothermal combined heat and power (GCHP) plant

The Hellisheiði GCHP plant is a double flash combined heat and power (CHP) plant with 303.3 MW of installed electric production capacity (6×45 MW high-pressure turbines and 1×33.3 MW low pressure turbine), and presently 133 MW of installed thermal production capacity for district heating purposes (see schematic representation in Fig. 1). Due to its modular design, the power plant can be analyzed as both a single flash and a double flash power plant by excluding or including the low-pressure part of the power plant as well as including or excluding the combined heat production.

<sup>2</sup> Bjarnarflag power plant (1969–present), Krafla power plant (1977–present), and Svartsengi power plant (1978–present).

<sup>3</sup> The first whole year of operation of the fully developed power plant was 2012, whereas the heat production was better optimized in 2013 than 2012.

#### 2.2.2 Functional unit and site-specific parameters

Hellisheiði GCHP has two main functions: generation of electricity and production of hot water for district heating. Furthermore, the generation of electricity is performed in two separate pressure stages: electricity produced with high-pressure turbines corresponding to a single flash power plant (blue color in Fig. 1) and the additional electricity produced with a low-pressure turbine (green color in Fig. 1), making the overall plant a double flash power plant. Thus, for the purpose of increasing the flexibility on applying the data, there are three functional units (FU) defined for the product system, two for the electricity produced from either SF or DF power plant setup and one for the heat produced. This allows the data on electricity production to be used as two reference datasets for either SF or DF power plants.

It is common practice to use 1 kWh of electricity as the functional unit for electricity generation and either 1 MJ or 1 kWh of heat for the production for district heating. The FUs for Hellisheiði GCHP are defined as *1 kWh of electricity produced at SF or DF plant* for the single or double flash plant setups and *1 MJ of produced heat*. The time horizon is 30 years of operation, and no transmission losses are taken into account since the electrical grid is outside the system boundary. For the same reasons, thermal losses in the distribution of heat to households are not included in this study.

In order to present the LCI so that it can be used and adjusted as secondary data for other flash power plants, the dataset for the *construction* stage is given in terms of parameterized unit processes with respect to *site-specific parameters* identified for scaling of data, i.e., a functional unit for each unit process.

#### 2.2.3 System boundary

The life cycle stages included in this LCI study are the construction, operation, and maintenance of the geothermal plant. The end-of-life stage is out of scope as it is site-specific. Furthermore, the transmission losses and the subsequent delivery of energy are not considered either as explained previously. For a full LCA study, these should however be included. Figure 2 shows the system boundary for the study.

While collecting inventory data, all available information on material and energy inputs and outputs were assessed for their inclusion in the LCI. Minor material exclusions that were considered not to be significant from a mass and environmental point of view included materials for components like computers, windows and doors, bolts and screws, and other material uses such as wood and paint. These components would have required rough estimations and assumptions, introducing a high level of uncertainty on materials which were expected to be irrelevant compared with the overall mass of wells, plant facilities, machinery, and pipelines. Transportation of materials and machinery to site was excluded from the LCI presented in this study as both means of transport and transport

**Fig. 1** A schematic representation of the Hellisheiði GCHP plant showing the flow of geothermal fluid through the main components of the energy conversion cycle. The blue color denotes the machinery used for electricity production from the high pressure units, green for electricity production from low-pressure units, and orange for hot water production (adapted from (Orkuveita Reykjavíkur 2013))

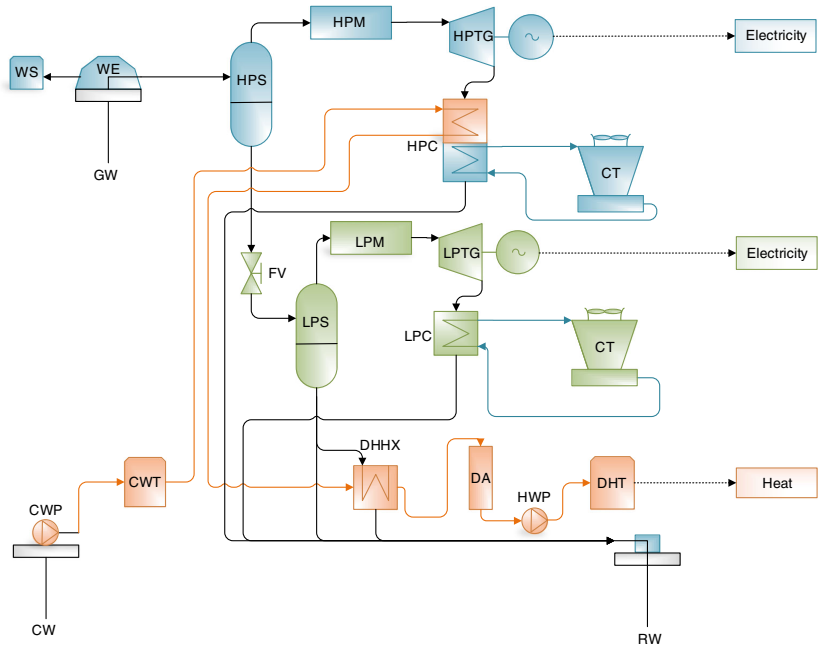

distances for materials and equipment vary greatly between sites. Transport should, however, always be taken into account when performing life cycle assessment studies. Many LCA databases provide detailed inventories for transport processes,

requiring the LCA practitioner to collect information on means of transport, distances, utilization rate, and the weight of transported goods. The processes included and excluded for the different parts of the power plant are presented in Table 1.

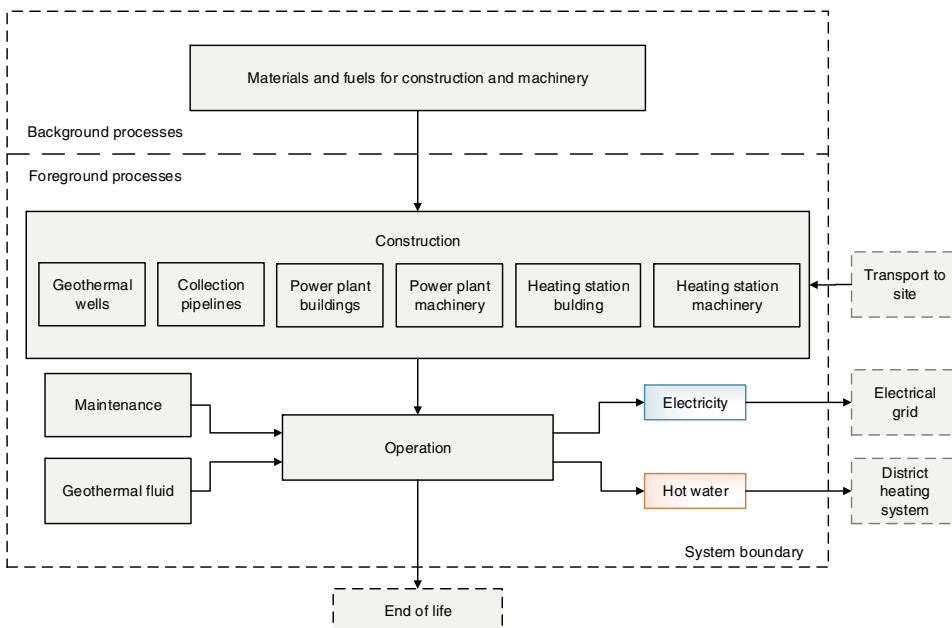

**Fig. 2** Flowchart showing the life cycle stages included and excluded from the system boundary chosen for the study of Hellisheiði GCHP



All data on the amount of materials used in construction, equipment, operation, and maintenance are primary data collected from the owner of the power plant. Energy use such as diesel fuel used in well drilling, geothermal fluid during operation, and the power plant's own use of electricity are primary data. Information on gaseous emissions from the power plant are measured and documented by the power plant owner. Secondary data were used to convert several primary data entries to material and energy flows as discussed in Section 3.10.1 for the final aggregation of data to the functional unit in Tables 13 and 14.

### 2.2.4 Principles for allocation

Hellisheiði GCHP plant produces electricity and hot water simultaneously, and thus there is a need for either assigning or allocating the inputs and outputs to the relevant output flow. At

the plant, the equipment and facilities used for the production of the electricity and heat are, to a large extent, separate, eliminating the need for allocation of inputs and outputs during the construction stage. This can be visualized in Fig. 1, where the blue and green colors denote equipment used for the production of electricity (blue for high pressure (*HP*) and green for low pressure (*LP*)), and the orange color denotes the equipment for the production of hot water. One noticeable exception is the high-pressure condenser (*HPC*), which is used for both electricity and heat production. The *HPC* is necessary in the electricity production, but, as it is partially used for preheating of hot water, it needs to be larger by 20–35 %. This additional weight of materials in the *HPC* is allocated to the hot water production to account for its share of the associated inputs and outputs.

For the operational and maintenance stage, it is possible to account for inputs and outputs separately for electricity and heat

**Table 1** Overview of the life cycle stages considered in this study and the information included and excluded from the inventory compilation

Life cycle stage	Included in inventory	Excluded from inventory
<b>Construction</b>		
Geothermal wells	Fuel and material use during well drilling and casing.	Drill rig infrastructure. Transport to site.
Collection pipelines	Earthworks and material requirements for wellhead equipment. Material use and earthworks for collection pipelines from wells to power station.	Energy for manufacturing equipment and structures. Transport to site. Energy for manufacturing and laying of pipelines.
Power plant buildings	Material and earthworks requirements for construction of turbine halls for high- and low-pressure stages, cold water works, and staff facilities. Materials for power hall piping system and electrical system (low-, medium-, and high-voltage cables).	Transport to site. Energy for manufacturing of pipelines. Interior design of buildings (doors, cabinets, etc.). Electrical control room and computers.
Power plant machinery	Materials for all main pieces of equipment as well as electrical transformers for low, medium and high voltage.	Transport to site. Energy for machinery manufacture.
Heating station buildings	Earthworks and material requirements for heating station and cold water work facilities. Material use for heating station piping and electrical system (low- and medium-voltage cables).	Transport to site. Energy for manufacturing of pipelines.
Heating station machinery	Materials for all main equipment and electrical transformers (low and medium voltage).	Transport to site. Energy for machinery manufacture.
<b>Operation</b>		
Operation of power station	Use of geothermal fluid, groundwater, and electricity. Emissions to air and soil from geothermal fluid. Heat rejection to air via cooling towers and to ground via reinjection and shallow wells.	Transport of staff.
Operation of heating station	Use of groundwater and electricity for pumping.	
<b>Maintenance</b>		
Maintenance of power station	Drilling of additional (make-up) wells. Addition of bleach (sodium hypochlorite, 15 %) to cooling water circuit.	Regular service maintenance on machinery where parts are overhauled and reused during a 30-year lifetime of the power plant.
Maintenance of heating station	Cleaning of heat exchangers resulting in silica deposit waste.	Regular service maintenance on machinery where parts are overhauled and reused during a 30-year lifetime of the power plant.

except for the input of geothermal fluid into the energy conversion cycle and its associated outputs. The geothermal fluid provides the energy from which both electricity and hot water are produced, and it releases airborne emissions, emissions to soil, and waste heat to air and soil during its use in the energy conversion cycle. For the purpose of this study, the inputs and outputs associated with the geothermal fluid are solely allocated to the electricity production. Consequently, the aggregated data set in Table 13 can easily be used for modelling geothermal power plants without heat production. By this, allocation procedures due to the use of geothermal fluid are avoided. However, allocation becomes unavoidable in the case of combined heat and power production, where allocation procedures chosen for the geothermal fluid can be applied differently by different LCA practitioners. Allocation based on exergy analysis, such as proposed by Tsatsaronis and Czesla (2003) and Lazzaretto and Tsatsaronis (2006), would provide a thermodynamic consistent way of allocating the impacts associated with drilling geothermal wells and the use of geothermal fluid to the two different products, electricity, and heat.

### 2.2.5 Data gathering and quality of data

The main aspects concerning data quality and representativeness are assessed in Table 2, showing the technology assessed, the age of the data, its geographical scope, and robustness. This assessment is presented for the readers and users of this LCI study so they get an overview of the origin of the data.

## 3 Results: life cycle inventory for Hellisheiði GCHP plant

In this section, the life cycle inventory of Hellisheiði GCHP plant is presented. First, the site-specific parameters identified for the construction of flash power plants are presented in

section 3.1. A discussion on the accuracy of data is given in section 3.2, while sections 3.3–3.9 present the underlying data for the construction and operation of the power plant and heating station. Section 3.10 gives the total aggregated inputs and outputs per FU for the production of electricity from both SF and DF setups and the combined heat production.

### 3.1 Site-specific parameters and use of data

The parameters that are considered to be a deciding factor in the amount of materials and energy consumption for the construction stage of a flash geothermal power plant are presented in Table 3, along with the corresponding values for Hellisheiði. These are amongst the minimum data to be collected in the case that no primary data are available. In this way, data for Hellisheiði GCHP can be used as secondary data (Table 4 to Table 9), by scaling to the site-specific parameters collected as in Table 3. Furthermore, data for the operational stage are site-specific and should always be gathered for individual plants. These include the use of geothermal fluid in Table 10 and operational and maintenance data for the power plant in Table 11 and heating station in Table 12.

### 3.2 Data accuracy

To indicate the level of accuracy of the collected data in Tables 4, 5, 6, 7, 8, 9, 10, 11, 12, 13, and 14, indicators are assigned to the data entries according to the following categorization:

- High accuracy (*h*): The presented data have a high level of accuracy due to detailed documentation from trusted primary sources in case of construction data or low temporal variations in case of operation and maintenance data. The data are likely to have been over- or underestimated by 5 %.

**Table 2** Data quality and representativeness

Indicator	Description
Technological representativeness	Best available technology (BAT)
Temporal representativeness	The data were gathered in 2010–2013 from expert surveys as well as tender documents and reports published in 2005–2013. The data represent directly the conditions during construction and operation of the GCHP plant in the time period of 2005–2012.
Geographical representativeness	The data apply directly to the Hengill high-temperature geothermal area in Iceland. The data can represent geothermal energy conversion in other high-temperature areas in Iceland or for high-temperature areas outside of Iceland with caution taken on site-specific data.
Reliability	The inventory for the foreground system is developed from technology-specific primary data provided mainly by Orkuveita Reykjavíkur, the power company in ownership of the Hellisheiði plant, and expert surveys from engineering consultants and manufacturers connected to the construction of the Hellisheiði plant. The majority of data on the construction stage are retrieved from tender documents for the construction of the power plant, where quantitative information is collected on all major material flows required for the constructions and machinery. The inventory information for the fluid collection and drilling is retrieved from reports done by the power company, including the power and performance of the wells drilled for the power and heat production. Data gaps in documents were treated by collecting information with expert surveys. The background system in this study consists of production of materials and fuels used for the construction, operation, and maintenance of the GCHP plant.

**Table 3** The site-specific parameters used for normalization of inventory data for the construction and operation of Hellisheiði GCHP plant

Site-specific parameter	Unit	Value for Hellisheiði
<b>Reservoir</b>		
Number of wells drilled	–	64
Total meters drilled	m	137,776
Collection pipelines	m	36,000
<b>Power plant</b>		
Installed capacity—double flash	MW	303.3
Installed capacity—single flash	MW	270
<b>Heating station</b>		
Installed capacity—heat production	MW <sub>th</sub>	133

- Moderate accuracy (*m*): The presented data have a moderate level of accuracy due to minor data gaps and/or need

**Table 4** Material, energy, and water requirements for the drilling of a geothermal well and wellhead equipment, scaled to either the total meters drilled or the number of wells

Geothermal well	Unit	Amount	Accuracy <sup>d</sup>
<b>Depth dependent material use</b>			
Steel <sup>a</sup>	kg/m <sub>wells</sub>	100.2	<i>h</i>
Diesel <sup>a</sup>	kg/m <sub>wells</sub>	53.1	<i>h</i>
<b>Average material use per well</b>			
Portland cement <sup>b</sup>	kg/well	81,332	<i>h</i>
Bentonite <sup>b</sup>	kg/well	59,643	<i>h</i>
Silica flour <sup>b</sup>	kg/well	28,860	<i>h</i>
Lignosulfonite	kg/well	2,791	<i>l</i>
Perlite <sup>b</sup>	kg/well	1,443	<i>l</i>
Water (in cement mix) <sup>c</sup>	kg/well	58,701	<i>l</i>
Water (in drilling)	kg/well	19,440,000	<i>l</i>
<b>Material requirements for wellhead equipment</b>			
Excavation	m <sup>3</sup> /well	3000	<i>h</i>
Fill	m <sup>3</sup> /well	1000	<i>h</i>
Concrete	m <sup>3</sup> /well	18	<i>h</i>
Steel	kg/well	14574	<i>h</i>
Stainless steel	kg/well	16	<i>h</i>
Aluminum	kg/well	1218	<i>h</i>

All amounts are calculated for average well design for Hellisheiði based on 77 % wide wells and 13 % narrow wells

BWOC by weight of cement

<sup>a</sup> Scaled per meter drilled. For drilling of 2,220 m average well at Hellisheiði, 222,000 kg of steel, and 117,847 kg of diesel are needed for drilling and casing

<sup>b</sup> Calculated from a concrete mix of 100 kg Portland cement, 40 kg silica flour (40 % BWOC), 2 kg Wyoming bentonite (2 % BWOC), and 2 kg perlite (2 % BWOC)

<sup>c</sup> Assuming 80 L of water per 144 kg cement mix

<sup>d</sup> See section 3.2 for definition of accuracy indicators *h*, *m*, and *l*

**Table 5** Material and construction work requirements for collection pipelines at Hellisheiði GCHP plant, scaled per meter of pipeline

Collection pipelines	Unit	Amount	Accuracy <sup>c</sup>
Excavation <sup>a</sup>	m <sup>3</sup> /m <sub>pipes</sub>	18	<i>l</i>
Fill <sup>a</sup>	m <sup>3</sup> /m <sub>pipes</sub>	8.3	<i>l</i>
Concrete <sup>a</sup>	m <sup>3</sup> /m <sub>pipes</sub>	0.3	<i>l</i>
Steel <sup>b</sup>	kg/m <sub>pipes</sub>	197	<i>l</i>
Aluminum <sup>c</sup>	kg/m <sub>pipes</sub>	6.2	<i>l</i>
Mineral wool <sup>d</sup>	kg/m <sub>pipes</sub>	43	<i>l</i>

Amounts for a total of 36 km of pipe length, where 43 % of total meters of pipe are DN1000, 44 % DN700, and 13 % DN500

<sup>a</sup> For pipe supports

<sup>b</sup> 86 % of steel used in pipes, 14 % used in supports. Black steel with density of 7850 kg/m<sup>3</sup>

<sup>c</sup> For cladding collection pipes with 1 mm aluminum shell with density of 2,700 kg/m<sup>3</sup>

<sup>d</sup> For insulating collection pipes with 100-mm-thick mineral wool with a density of 150 kg/m<sup>3</sup>

<sup>e</sup> See section 3.2 for definition of accuracy indicators *h*, *m*, and *l*

for extrapolation of data for full coverage of processes in construction data or moderate temporal variations in case of operation and maintenance data. The data are likely to have been over- or underestimated by 10 %.

- Low accuracy (*l*): The presented data have the lowest level of accuracy due to major data gaps that required considerable estimations and/or calculations of data values in construction data. Calculation procedures were based on expert advice and extrapolation of data based on few data points. Operational and maintenance data in this category are expected to have high temporal variations. It is estimated that the data are likely to be over- or underestimated by 20–30 %.

### 3.3 Geothermal wells

#### 3.3.1 Well drilling and casing

For the installed capacity of 303.3 MW, 64 wells have been drilled at Hellisheiði. Of the 64 wells, 47 are production wells (*GW* in Fig. 1) and 17 reinjection wells (*RW* in the same figure). They are drilled in sections and supported with casings consisting of concrete and steel for the support of the well opening. Both production wells and reinjection wells usually share the same structural design and wellhead equipment.

The main materials used to drill and construct a well are listed in Table 4. Drilling rigs in Iceland are powered with diesel fuel, and a large amount of water is used in the drilling process. Diesel use during drilling can vary between different geothermal sites, according to the drill rig selected as well as geological conditions (Sullivan et al. 2010). Material use during drilling and casing that accounted for less than 0.5 % of the

**Table 6** Material and construction work requirements for the power plant buildings for the single flash (SF) and double flash (DF) setup at Heillishéiði CHP, scaled per MW of installed capacity for SF and DF

Power plant buildings	Unit	Amount SF	Amount DF	Accuracy <sup>i</sup>
Excavation <sup>a</sup>	m <sup>3</sup> /MW <sub>SF,DF</sub>	2,165	2,136	<i>m</i>
Fill <sup>b</sup>	m <sup>3</sup> /MW <sub>SF,DF</sub>	2,432	2,443	<i>m</i>
Concrete	m <sup>3</sup> /MW <sub>SF,DF</sub>	86	91	<i>m</i>
Steel <sup>c</sup>	kg/MW <sub>SF,DF</sub>	11,943	13,057	<i>m</i>
Stainless steel <sup>d</sup>	kg/MW <sub>SF,DF</sub>	517	738	<i>m</i>
Aluminum <sup>e</sup>	kg/MW <sub>SF,DF</sub>	578	577	<i>m</i>
Copper <sup>f</sup>	kg/MW <sub>SF,DF</sub>	152	150	<i>l</i>
Mineral wool	kg/MW <sub>SF,DF</sub>	567	594	<i>m</i>
Plastic <sup>g</sup>	kg/MW <sub>SF,DF</sub>	702	729	<i>l</i>
Asphalt <sup>h</sup>	kg/MW <sub>SF,DF</sub>	31,624	36,108	<i>l</i>

<sup>a</sup> 7 % for construction of roads and preparation of land, 90 % for power house, 2 % for cold water works, and 1 % for staff facilities

<sup>b</sup> 23 % for construction of roads and preparation of land, 76 % for power house, 1 % for staff facilities

<sup>c</sup> Mostly, 316 L grade stainless steel

<sup>d</sup> For reinforcement of concrete, support beams, and machinery supports

<sup>e</sup> Sheets for wall and roof cladding

<sup>f</sup> In electrical wires, calculated from length, cross-sectional area, and density of 8,790 kg/m<sup>3</sup>

<sup>g</sup> 60 % polyethylene (PE) plastic and 40 % polyvinylchloride (PVC) plastic for piping

<sup>h</sup> Asphalt for roads is estimated by the assumption of 50-mm-thick asphalt with a density of 2,360 kg/m<sup>3</sup>

<sup>i</sup> See section 3.2 for definition of accuracy indicators *h*, *m*, and *l*

total mass of material (excluding water and diesel use) is omitted in the inventory table<sup>4</sup>.

For calculating water consumption during drilling, the following assumptions were made based on expert survey:

- 30 l/s pumping rate
- Water is used during one third of drilling time
- Drilling duration is 12 h per day
- Average drilling time of 45 days per well (Sveinbjornsson and Thorhallsson 2014)

### 3.3.2 Wellhead equipment and structures

Table 4 also presents separate data for the use of materials and construction work required for the installation of wellhead structures and equipment. The wellhead equipment for each well includes a well silencer (*WS* in Fig. 1) and an aluminum well housing (*WE*) containing a main wellhead valve as well as piping and smaller valves.

<sup>4</sup> Materials omitted were drilling foam, fluid loss additives, and cement retarder.

**Table 7** Material amounts for the main machinery used in the SF and DF stages, scaled per MW of installed capacity for SF and DF

Machinery	unit	Amount, SF	Amount, DF	Accuracy <sup>e</sup>
Steel <sup>a</sup>	kg/MW	8,616	9,015	<i>h</i>
Stainless steel <sup>b</sup>	kg/MW	2,343	2,114	<i>h</i>
Aluminum	kg/MW	242	255	<i>l</i>
Copper <sup>a</sup>	kg/MW	363	377	<i>m</i>
Titanium	kg/MW	523	465	<i>h</i>
Mineral wool	kg/MW	246	264	<i>m</i>
Plastic <sup>c</sup>	kg/MW	8	9	<i>m</i>
GRP <sup>d</sup>	kg/MW	2,116	2,142	<i>h</i>
Transformer oil <sup>a</sup>	kg/MW	662	683	<i>m</i>

<sup>a</sup> Amounts of steel, copper, and transformer oil estimated from total weight and the material composition presented by Lo Rizzo (2003)

<sup>b</sup> 316 L grade stainless steel

<sup>c</sup> 100 % PE plastic

<sup>d</sup> Fiberglass reinforced plastic

<sup>e</sup> See section 3.2 for definition of accuracy indicators *h*, *m*, and *l*

### 3.4 Collection pipelines

The total length of collection pipelines at Heillishéiði is roughly 36 km with three different nominal pipe sizes: DN500, DN700, and DN1000. The collection pipelines are made of steel, insulated with mineral wool, and clad with aluminum sheets. The pipes transport two phase geothermal fluid

**Table 8** Material and construction work for the facilities connected to the production of hot water, scaled per MW of installed thermal production capacity

Heating station building	Unit	Amount	Accuracy <sup>g</sup>
Excavation <sup>a</sup>	m <sup>3</sup> /MW <sub>th</sub>	767	<i>h</i>
Fill <sup>b</sup>	m <sup>3</sup> /MW <sub>th</sub>	563	<i>h</i>
Concrete	m <sup>3</sup> /MW <sub>th</sub>	30	<i>h</i>
Steel <sup>c</sup>	kg/MW <sub>th</sub>	22,058	<i>h</i>
Stainless steel <sup>d</sup>	kg/MW <sub>th</sub>	252	<i>l</i>
Aluminum <sup>e</sup>	kg/MW <sub>th</sub>	294	<i>l</i>
Copper	kg/MW <sub>th</sub>	66	<i>l</i>
Mineral wool <sup>f</sup>	kg/MW <sub>th</sub>	249	<i>l</i>
Asphalt	kg/MW <sub>th</sub>	1,770	<i>l</i>

These include the cold water works, heating station, pumping station, and control house

<sup>a</sup> 59 % for heating station buildings, 41 % for cold water works pipe

<sup>b</sup> 47 % for heating station buildings, 53 % for cold water works pipe

<sup>c</sup> 63 % in cold water pipe (ductile iron), 27 % as structural steel in buildings, 10 % in pipes

<sup>d</sup> 316 L grade stainless steel used in pipes

<sup>e</sup> 79 % in cladding of constructions, 21 % in cladding of pipes

<sup>f</sup> 89 % in pipe insulation, 11 % in building insulation

<sup>g</sup> See section 3.2 for definition of accuracy indicators *h*, *m*, and *l*

**Table 9** Main materials for the heating station machinery for the hot water production, scaled per MW of installed thermal production capacity

Heating station machinery	Unit	Amount	Accuracy <sup>f</sup>
Steel <sup>a</sup>	kg/MW <sub>th</sub>	192	<i>l</i>
Stainless steel <sup>b</sup>	kg/MW <sub>th</sub>	835	<i>h</i>
Aluminum <sup>c</sup>	kg/MW <sub>th</sub>	7	<i>m</i>
Copper	kg/MW <sub>th</sub>	6	<i>l</i>
Mineral wool insulation <sup>d</sup>	kg/MW <sub>th</sub>	35	<i>m</i>
Plastic <sup>e</sup>	kg/MW <sub>th</sub>	1.1	<i>l</i>

<sup>a</sup> 37 % in hot water pumps (HWP in Fig. 1), 37 % in electrical transformers, 20 % in deairators (DA in Fig. 1), and 6 % in cold water pumps (CWP in Fig. 1)

<sup>b</sup> 72 % in heat exchangers (DHHX in Fig. 1), 19 % in deairators (DA), and 9 % in cold water pumps (CP). 316 L grade stainless steel

<sup>c</sup> 74 % in DHHX, 26 % in DA

<sup>d</sup> 78 % in DHHX, 22 % in DA

<sup>e</sup> 100 % PE plastic

<sup>f</sup> See section 3.2 for definition of accuracy indicators *h*, *m*, and *l*

(steam and brine) from the wells to the separators (*HPS* in Fig. 1). They rest on supports made of concrete and steel, requiring some construction work for installation. The collection pipelines are sized and designed based on mass flow from

wells and the layout of each geothermal field so the material inputs can vary greatly between power plants. Table 5 presents the material and construction work per meter of collection pipeline at Hellisheiði power plant. The material amounts for the pipelines are calculated from material volumes of pipe segments and density of the materials.

### 3.5 Power plant buildings

The inventory in Table 6 is presented for both the SF and DF setups at Hellisheiði GCHP. For the SF setup, the data includes: construction of power house, staff facilities, power house piping, and cold water works. For the additional low-pressure (LP) stage included in the DF setup, only the LP power house built is added.

### 3.6 Power plant machinery

The main machinery at Hellisheiði power plant can be seen in Fig. 1, represented by blue and green colors for the different pressure stages of the electricity production. For the SF setup, 21 steam separators (*HPS*), 12 moisture removers (*HPM*), 6 turbine-generator sets (*HPTG*), 6 condensers (*HPC*), and 6

**Table 10** Unit process for the use of geothermal fluid in Hellisheiði GCHP, scaled to 1 kg of use

	Input/output	Unit	Amount	Accuracy <sup>a</sup>			
Output to technosphere							
Geothermal fluid, 1 kg at plant		kg	1	–			
Resources (inputs from ecosphere)							
Brine, from ground	Input	kg	0.52	<i>m</i>			
Steam, from ground	Input	kg	0.48	<i>m</i>			
Emissions to air							
CO <sub>2</sub>	Output	g	1.40	<i>m</i>			
H <sub>2</sub> S	Output	g	0.36	<i>m</i>			
H <sub>2</sub>	Output	g	1.5E-02	<i>m</i>			
CH <sub>4</sub>	Output	g	2.1E-03	<i>m</i>			
Final waste flows							
Brine, reinjected	Output	kg	0.45	<i>m</i>			
Steam, evaporated condensate	Output	kg	0.09	<i>m</i>			
Condensate, to shallow wells	Output	kg	0.24	<i>m</i>			
Condensate, reinjected	Output	kg	0.22	<i>m</i>			
Energy flows							
			SF no heat	SF with heat	DF no heat	DF with heat	
Thermal energy, geothermal fluid	Input	kJ	1,691	1,691	1,691	1,691	<i>m</i>
Power, produced at plant	Output	kJ	257.1	257.1	288.9	288.9	<i>m</i>
Waste heat, from cooling tower	Output	kJ	1,059	967.5	1,171	1,110	<i>m</i>
Waste heat, condensate to shallow wells	Output	kJ	14.3	14.3	15.6	15.6	<i>m</i>
Waste heat, to thermal production	Output	kJ	–	148	–	148.0	<i>m</i>
Thermal energy, reinjected	Output	kJ	360.6	304.0	215.2	128.1	<i>m</i>

Energy flows are given for the case of both DF and SF production with or without combined heat and power production

<sup>a</sup> See section 3.2 for definition of accuracy indicators *h*, *m*, and *l*

**Table 11** Site specific operational and maintenance data for the electricity production at Hellisheiði GCHP

Operational and maintenance data for power plant	Input/output	Unit	Amount	Accuracy <sup>f</sup>
<b>Power plant parameters</b>				
Capacity factor	–	%	0.87	<i>h</i>
Life time	–	years	30	–
<b>Operation</b>				
Geothermal fluid <sup>a</sup>	Input	kg/s	1,050	<i>l</i>
Groundwater	Input	kg/s	300	<i>l</i>
Auxiliary power demand factor <sup>b</sup>	Input	%	4	<i>l</i>
<b>Maintenance</b>				
Make up wells <sup>c</sup>	Input	wells	16	<i>l</i>
Collection pipelines <sup>d</sup>	Input	m	9,000	<i>l</i>
Sodium hypochlorite <sup>e</sup> (amount per cooling tower)	Input	kg	100,000	<i>m</i>

<sup>a</sup>Detailed inventory given in Table 10

<sup>b</sup>Based on total produced electricity at Hellisheiði GCHP

<sup>c</sup>Including wellhead equipment. Each make up well assumed to be 2,220 m deep. Detailed inventory is given in Table 4

<sup>d</sup>Length of collection pipelines for connecting make up wells to power plant is calculated from the average length per well in construction phase

<sup>e</sup>Added to cooling circuit for regular cleaning. SF setup has six cooling towers while DF setup has seven cooling towers

<sup>f</sup>See section 3.2 for definition of accuracy indicators *h*, *m*, and *l*

cooling towers (*CT*) are used for the installed HP capacity of 270 MW. The machinery for the low-pressure stage included in the DF setup is represented with a green color in Fig. 1 and includes a throttle valve (*FV*), 2 low pressure steam separators (*LPS*), 2 moisture removers (*LPM*), one 33.3-MW turbine generator set (*LPTG*), one condenser (*LPC*), and a cooling tower (*CT*). Also, for each of the *HPTGs* and the *LPTG*, a set of 50 MVA and 12.5 MVA power transformers along with two 2.5 MVA station service transformers are installed at the power plant (not shown in Fig. 1). For the supply of cold water for cooling of machinery, two cold water pumps (not shown in Fig. 1 for electricity production) located at the cold water works are assigned to the power plant machinery, with 14 % of the pump materials assigned to the LP unit and 86 % to the HP units<sup>5</sup>. The material amounts for the machinery used for electricity production for the SF and DF setup is presented in Table 7.

### 3.7 Heating station building

The buildings associated with the production of hot water for district heating are: pumping station, control house, cold water

<sup>5</sup> Allocation of cold water pump materials is based on the amount of HP (6 units) and LP (1 unit) units assuming the cold water requirements are equally divided between each of the seven turbine-generator sets.

works, and the heating station. Also, piping to connect machinery within these facilities is taken into account here. Furthermore, pipes are required for the cold water work to transport water intended for hot water production from wells towards the power house where the first stage of hot water production takes place. The main pipe is a 6 km long DN900 ductile pipe, transporting water from six cold water (*CW*) wells. Table 8 presents the material and construction work needed for the heating station facilities.

### 3.8 Heating station machinery

The total material requirement for the heating station equipment, presented by an orange color in Fig. 1, is presented in Table 9. For pumping of cold water towards the heat production, four pumps (*CWP*) in the cold water works are assigned to the heating station machinery. Inside the power house, the *HPCs* are used partially for preheating of the water. The additional material requirements of stainless steel, titanium, mineral wool, and aluminum for the *HPCs* due to the preheating part are accounted for in the inventory in Table 9. Within the heating station, four heat exchangers (*DHHX*) are used to heat up preheated water to its final temperature of about 83–90 °C. Two deairators (*DA*) are also located in the heating station along with five hot water pumps (*HWP*) pumping water to the storage tank (*DHT*).

### 3.9 Operational and maintenance data

#### 3.9.1 Electricity generation

The operation and maintenance of geothermal power plants is extremely site-specific. Each geothermal resource has its unique characteristics of available mass flows, temperatures, and chemical composition of the geothermal fluid. The different power plants installed can have varying operational parameters such as the ratio between the actual power output to the installed potential (capacity factor), groundwater needs, and auxiliary power demand. The maintenance is governed by the need for additional wells to sustain the production during the plant's lifetime. Information on the geothermal fluid composition at Hellisheiði and the power plant's operational and maintenance data are presented in Tables 10 and 11. Because of the site-specific nature of the data, LCA practitioners should gather these corresponding to the geothermal fluid and power plant under evaluation.

The characteristics of the geothermal fluid presented in Table 10 are related to the use of 1 kg of the fluid at the power plant during *operation*. It contains a mixture of steam and brine, and due to dissolved non-condensable gasses (NCGs), direct emissions to air occur during the operation of the power plant. These gasses are mainly CO<sub>2</sub>, H<sub>2</sub>S, CH<sub>4</sub>, and H<sub>2</sub>. The energy input from the fluid is 1,712 kJ/kg (Gunnlaugsson

**Table 12** Site-specific operational and maintenance data for the production of hot water at the heating station of Hellisheiði GCHP

Operational and maintenance data for heating station	Input/output	Unit	Amount	Accuracy <sup>e</sup>
Heating station parameters				
Average usable heat production for service life (30 years) <sup>a</sup>	–	kJ/s	91,441	<i>l</i>
Operation				
Groundwater	Input	kg/s	436.5	<i>l</i>
Electricity <sup>b</sup>	Input	kJ/s	1,446	<i>l</i>
Waste heat, from geothermal <sup>c</sup>	Input	kJ/s	155,377	<i>l</i>
Maintenance				
Silica	Output	g/s	0.006	<i>l</i>
Additional heating station machinery <sup>d</sup>	Input	MW <sub>th</sub>	133	<i>h</i>

Values are given as estimated average values based on 30 years of continuous future operation

<sup>a</sup> Usable heat based on enthalpy difference of water at 90 °C and 40 °C

<sup>b</sup> Derived from the known electrical rating of the cold water pumps (530 kW) and their maximum flow rate (160 kg/s)

<sup>c</sup> Waste heat based on enthalpy difference of water at 90 °C and 5 °C

<sup>d</sup> Detailed inventory, scaled to the installed thermal capacity (MW<sub>th</sub>), is given in Table 9

<sup>e</sup> See section 3.2 for definition of accuracy indicators *h*, *m*, and *l*

2012), but all thermal energy flows presented are calculated according to a reference state of water at 5 °C (21 kJ/kg) which is close to the average annual temperature at Hellisheiði. The mass and energy content of the waste fluid during *operation* is also accounted for in Table 10, where the changes in energy flows are shown according to different plant setups (SF and DF, with or without heat production). Brine that is reinjected contains thermal energy and dissolved chemicals (SiO<sub>2</sub>, Na, Cl, K, and Al in small concentrations), but its associated emissions are not accounted for as environmental impact methods are unavailable. Steam condensate from condensers is used as make-up water in the cooling circuit, and the rest is reinjected with the brine with a small amount released to shallow wells along with the blowdown water from cooling towers. The chemical content of the condensate is negligible, but waste heat is released to air due to evaporation and cooling in cooling towers, and soil as a result of shallow well disposal. Furthermore, in combined heat and power production, some amount of waste heat is utilized for the heat production, reducing the waste heat both in reinjected fluid and from cooling towers.

The operational parameters in Table 11 are based on values for Hellisheiði GCHP in 2012. For the *operation* of all seven turbines for the installed capacity of 303.3 MW<sub>el</sub>, 1,050 kg/s of geothermal fluid is needed. The use of steam condensate as make-up water in the cooling circuit eliminates the need for

large amounts of groundwater, but a small amount is used for the regulation of pH value within the system. The demand for groundwater during *operation* is mainly for cooling of various small equipment and amounts to 300 kg/s. The auxiliary power demand is 4 % of the total electricity produced at the plant.

The response of the geothermal system to the fluid extraction during operation of the power plant can vary greatly between sites, and usually, additional (make-up) wells are drilled and new collection pipelines laid for *maintenance* of the power production during the lifetime of the power plant. The wells share the same design as the original wells drilled during construction, and similar collection pipelines are assumed so data given in Tables 4 and 5 also apply for the maintenance stage. Also, some amount of sodium hypochlorite is added to cooling circuit for regular cleaning of cooling towers. Table 11 presents the need for make-up wells and additional collection pipelines as well as sodium hypochlorite for Hellisheiði GCHP.

### 3.9.2 Heat production

Thermal production at GCHP plants varies greatly according to the heat demand from the district heating system. The heat demand depends on the climate, which makes it very site-specific. In Iceland, space heating is required all year round due to climate conditions. The 133-MW<sub>th</sub> capacity of the heating station at Hellisheiði is based on the usable heat content for district heating purposes in the hot water produced, calculated as the heat released from radiators while the water cools from 90 °C to 40 °C.

Figure 3 shows the forecasted heat production at Hellisheiði in MJ for the years 2014, 2023, and 2043. The prediction is based on the assumption of 2 % increase in hot water demand per year with reference to average data for heat demand in the Reykjavik district heating system in 2011–2013. In 2023, the thermal plant is first expected to reach its maximum production capacity. In 2043, the 133-MW<sub>th</sub> unit is expected to produce at maximum capacity 8 months of the year. To sustain a reliable district heating system, the heating station at Hellisheiði has to be expanded with additional heat exchangers for hot water production no later than in 2023 according to these predictions. The expected total production of usable heat over 30 years of operation is 8.65E+10 MJ according to assumptions made.

Table 12 presents the main inputs and outputs related to the operation and maintenance of the hot water production at Hellisheiði GCHP. The main input during *operation* is groundwater, used for the production of hot water, and waste heat from the power station. The water requirement for the maximum production of 133 MW<sub>th</sub> is 650 l/s of 90 °C hot water, which equals 627.4 kg/s<sup>6</sup>. For the production of 8.65E+10 MJ over the 30-year lifetime of the power plant, the average

<sup>6</sup> The density of 90 °C hot water is 0.9653 kg/l

**Table 13** Hellišhetöi GCHP plant's inputs and outputs per functional unit of electricity production (1 kWh) with a breakdown for the 270 MW single flash (SF) and 303.3 MW double flash (DF) stages

Inputs and outputs	Input/output	Unit	Construction		Operation		Maintenance		Total		Accuracy
			SF	DF	SF	DF	SF	DF	SF	DF	
<b>Natural resources</b>											
Geothermal fluid	Input	g/kWh	–	–	1.40E+04	1.25E+04	–	–	1.40E+04	1.25E+04	l
Groundwater	Input	g/kWh	20.3	18.1	4,000	3,561	5.1	4.5	4,025	3,583	l
<b>Energy flows and fuels</b>											
Thermal energy, geothermal fluid	Input	kJ/kWh	–	–	2.37E+04	2.11E+04	–	–	2.37E+04	2.11E+04	m
Thermal energy, reinjected fluid	Output	kJ/kWh	–	–	4,256	1,596	–	–	4,256	1,596	m
Waste heat, from cooling towers	Output	kJ/kWh	–	–	1.35E+04	1.38E+04	–	–	1.35E+04	1.38E+04	m
Waste heat, condensate to shallow wells	Output	kJ/kWh	–	–	200	194	–	–	200	194	m
Waste heat, to thermal production	Output	kJ/kWh	–	–	2,072	1,844	–	–	2,072	1,844	m
Electricity	Input	kJ/kWh	–	–	139	144	–	–	139	144	l
Diesel	Input	kJ/kWh	5.4	4.8	–	–	1.3	1.2	6.7	6.0	h
<b>Earthwork requirements</b>											
Excavation	Input	m <sup>3</sup> /kWh	2.3E-05	2.1E-05	–	–	3.4E-06	3.0E-06	2.7E-05	2.5E-05	m
Fill	Input	m <sup>3</sup> /kWh	1.7E-05	1.6E-05	–	–	1.3E-06	1.3E-06	1.8E-05	1.7E-05	m
<b>Products consumption</b>											
Portland cement	Input	g/kWh	0.27	0.26	–	–	0.04	0.03	0.30	0.29	m
Steel	Input	g/kWh	0.45	0.42	–	–	0.09	0.08	0.54	0.50	m
Stainless steel	Input	g/kWh	1.3E-02	1.2E-02	–	–	4.2E-06	3.8E-06	1.3E-02	1.2E-02	h
Aluminum	Input	g/kWh	8.5E-03	8.0E-03	–	–	1.2E-03	1.1E-03	9.7E-03	9.1E-03	m
Copper	Input	g/kWh	2.3E-03	2.3E-03	–	–	–	–	2.3E-03	2.3E-03	m
Mineral wool	Input	g/kWh	2.9E-02	2.6E-02	–	–	6.3E-03	5.6E-03	3.5E-02	3.2E-02	l
Asphalt	Input	g/kWh	0.14	0.16	–	–	–	–	0.14	0.16	l
Plastic	Input	g/kWh	3.1E-03	3.2E-03	–	–	–	–	3.1E-03	3.2E-03	l
Glass fiber reinforced plastic (GRP)	Input	g/kWh	9.3E-03	9.4E-03	–	–	–	–	9.3E-03	9.4E-03	h
Transformer oil	Input	g/kWh	2.9E-03	3.0E-03	–	–	–	–	2.9E-03	3.0E-03	m
Silica flour	Input	g/kWh	3.0E-02	2.7E-02	–	–	7.5E-03	6.7E-03	3.8E-02	3.4E-02	h
Bentonite	Input	g/kWh	6.3E-02	5.6E-02	–	–	1.5E-02	1.4E-02	7.9E-02	7.0E-02	h
Lignosulfonate	Input	g/kWh	2.9E-03	2.6E-03	–	–	7.2E-04	6.4E-04	3.6E-03	3.2E-03	l
Sodium hypochlorite	Input	g/kWh	–	–	–	–	1.2E-02	1.3E-02	1.2E-02	1.3E-02	m
<b>Air emissions</b>											
CO2	Output	g/kWh	–	–	19.6	17.5	–	–	19.6	17.5	m
H2S	Output	g/kWh	–	–	5.0	4.5	–	–	5.0	4.5	m
H2	Output	g/kWh	–	–	0.21	0.19	–	–	0.21	0.19	m
CH4	Output	g/kWh	–	–	0.03	0.03	–	–	0.03	0.03	m



**Table 13** (continued)

Inputs and outputs	Input/output	Unit	Construction		Operation		Maintenance		Total		Accuracy
			SF	DF	SF	DF	SF	DF	SF	DF	
<b>Waste flows</b>											
Brine, reinjected	Output	g/kWh	–	–	6,300	5,608	–	–	6,300	5,608	<i>m</i>
Steam, evaporated condensate	Output	g/kWh	–	–	1,260	1,122	–	–	1,260	1,122	<i>m</i>
Condensate, to shallow wells	Output	g/kWh	–	–	3,360	2,991	–	–	3,360	2,991	<i>m</i>
Condensate, reinjected	Output	g/kWh	–	–	3,080	2,742	–	–	3,080	2,742	<i>m</i>

See section 3.2 for definition of accuracy indicators *h*, *m*, and *l*

need for groundwater for heating is 436.5 kg/s. The input of waste heat is calculated from heating groundwater at 5 °C to 90 °C. Electricity use during *operation* is for pumping. For the *maintenance* of the heating station, regular cleaning of silica scaling in heat exchangers is needed as well as additional machinery for the expansion of the heating station. An estimated disposal of silica deposits is 175 kg/year<sup>7</sup>. The expansion of the heating station is expected to be 133 MW<sub>th</sub>, and the additional material requirements are thus derived from scaling the inventory data given in Table 9. Other maintenance activities include machinery overhaul and are not taken into account in this study.

### 3.10 Total inventory for Hellisheiði GCHP plant

#### 3.10.1 Data conversion procedures from secondary data sources

For the presentation of the total aggregated inventory per FU, secondary data sources were used to account for diesel fuel use during excavation and fill processes and water and cement use in ready-made concrete mix. These calculation procedures are explained below.

*Water consumption* The preparation of concrete mix consumes large amounts of water, and this has been accounted for by the following assumptions:

- In geothermal cement for casing of wells, 550 L of water is needed per ton of dry cement mix
- In concrete for buildings, an estimated amount of 210 L of water per cubic meter of concrete was used (Cement Concrete & Aggregates Australia 2004)

*Cement in concrete* Concrete is one of the main materials used in the construction of Hellisheiði. To convert the volume of concrete to mass of cement, a density of 320 kg cement per cubic meter concrete is used (Cement Concrete & Aggregates Australia 2004).

*Diesel fuel used during construction* For the purpose of estimating diesel use in building equipment, volumes of excavation and fill was converted to mass of diesel fuel by usingecoinvent data (ecoinvent Centre 2007). Mass of diesel fuel was converted to kilojoules with the lower heating value of 43,400 kJ/kg.

#### 3.10.2 Life cycle inventory for electricity production at Hellisheiði GCHP

The life cycle inputs and outputs for the production of electricity at Hellisheiði GCHP are presented in Table 13 for both

<sup>7</sup> Estimated by expert survey.

**Table 14** Hellisheiði GCHP plant life cycle inputs and outputs per functional unit of heat production (1 MJ)

Inputs and outputs	Input/output	Unit	Construction	Operation	Maintenance	Total	Accuracy
Natural resources							
Groundwater	Input	g/MJ	9.8E-03	4.8E+03	–	4.8+03	<i>l</i>
Energy and fuels							
Electricity, from geothermal	Input	kJ/MJ	–	15.8	–	15.8	<i>l</i>
Waste heat, from geothermal	Input	kJ/MJ	–	1.7E+03	–	1.7E+03	<i>m</i>
Diesel	Input	kJ/MJ	1.2E-02	–	–	1.2E-02	<i>m</i>
Earthwork requirements							
Excavation	Input	m <sup>3</sup> /MJ	1.2E-06	–	–	1.2E-06	<i>h</i>
Fill	Input	m <sup>3</sup> /MJ	8.7E-07	–	–	8.7E-07	<i>h</i>
Products consumption							
Portland cement	Input	g/MJ	1.5E-02	–	–	1.5E-02	<i>m</i>
Steel	Input	g/MJ	3.4E-02	–	3.0E-05	3.4E-02	<i>h</i>
Stainless steel	Input	g/MJ	1.7E-03	–	1.3E-04	1.8E-03	<i>m</i>
Aluminium	Input	g/MJ	4.6E-04	–	1.1E-06	4.7E-04	<i>l</i>
Copper	Input	g/MJ	1.1E-04	–	9.2E-07	1.1E-04	<i>l</i>
Mineral wool	Input	g/MJ	4.4E-04	–	5.4E-06	4.4E-04	<i>l</i>
Asphalt	Input	g/MJ	2.7E-03	–	–	2.7E-03	<i>l</i>
Plastic	Input	g/MJ	1.7E-06	–	1.7E-07	1.8E-06	<i>l</i>
Waste flows							
Silica	Output	g/MJ	–	–	6.1E-05	6.1E-05	<i>l</i>

See section 3.2 for definition of accuracy indicators *h*, *m*, and *l*

the SF and DF setups with combined heat production. The cut-off criteria of 0.25 % of the total material amounts during construction (excluding water and diesel) was selected, mainly resulting in exclusion of specialized materials used during drilling of geothermal wells and not considered significant in relation to the overall potential environmental impacts of the plant.<sup>8</sup> Other materials excluded due to cut-off are lubricating oil and paint.

To convert the amounts of materials and energy used for the production of electricity into total aggregated amounts per FU in Table 13, some data calculations have to be performed. For Hellisheiði GCHP, the total forecasted electricity produced (in kilowatt-hour) over the 30-year lifetime is used as a basis for the FU, derived from the site-specific capacity factor given in Table 11 and the installed (either SF or DF) capacity of the plant. For the *construction* stage, the data in Tables 4, 5, 6, and 7 are scaled according to the appropriate site-specific parameter collected by LCA practitioners or given for Hellisheiði GCHP in Table 3, and for the *operational* and *maintenance* stages, data in Table 11 are used, including the detailed inventory table for the geothermal fluid in Table 10.<sup>9</sup> The total material and energy amounts (in relevant units such as kilograms,

kilojoules, or grams) then have to be scaled to the total forecasted electricity produced (in kilowatt-hour).

### 3.10.3 Life cycle inventory for hot water production at Hellisheiði GCHP

In Table 14, the inputs and output associated with the functional unit of 1 MJ heat produced as hot water at Hellisheiði GCHP are presented. The only output accounted for in the table is silica scaling removed from heat exchangers during regular maintenance, as no direct emissions are released during the heating process under normal operation. To convert the data given for the *construction* stage (Tables 8 and 9) to total aggregated amounts per FU, the data are scaled by using the relevant site-specific parameter. For the *operational* and *maintenance* stages, data in Table 12 are used and all data finally scaled to the total forecasted heat production calculated from the average production (given in kilojoules per second in Table 12) assuming continuous future operation over 30 years.

## 4 Results and discussion

The data presented here by scaling to a relevant site-specific parameter assume a linear relationship between the inputs and outputs and the site-specific parameter in question. For the

<sup>8</sup> Material excluded are perlite, cement retarder, fluid loss additives, and drilling foam.

<sup>9</sup> Energy flows including the combined heat production are used from Table 11 for the aggregated values in Table 13.

**Fig. 3** Predicted hot water produced per month at Hellisheiði in 2014, 2023, and 2043. Maximum capacity of the 133 MW<sub>th</sub> production is equivalent to 349.5 million MJ. Prediction is based on the assumption of 2 % increase in hot water demand per year based on reference year for heat demand in the Reykjavik district heating system in 2011–2013

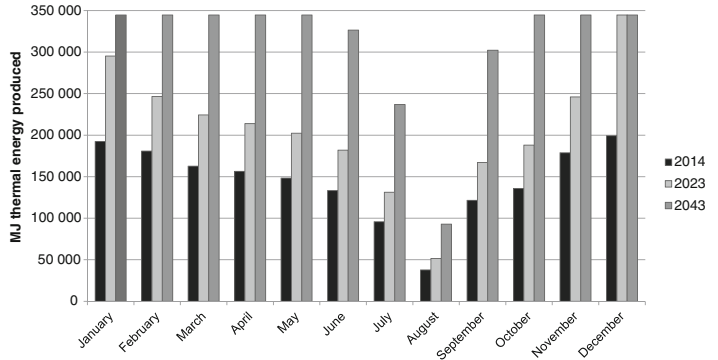

wells at Hellisheiði GCHP, an analysis of the material burdens for 40 wells shows either a linear relationship with the depth of the well (for steel and diesel fuel use) or a constant material requirement per well independent of the depth. These results are the basis for the inventory table (Table 4) for the geothermal wells. For other parts of the power plant, this assumption of linear relations can be debated. Other scaling methods could be applied for the purpose of improving representativeness of the data for power plants of different sizes and well field design, such as relating the collection pipeline to the pipeline diameters. A study by Gerber et al. (2011) partially addresses these issues and proposes a method of scaling the final life cycle impacts of process equipment in a similar manner as for equipment costs estimation, using either derived exponents for individual equipment or the commonly known sixth-tenth rule if no specific exponents are available. For the scaling of materials for construction of facilities, many different factors can affect the material inputs such as architectural and structural design, size of equipment, and climate conditions, and thus, it may prove difficult to develop a method for scaling material amounts for construction. The use of secondary data for foreground processes however will always introduce some level of non-representativeness in LCA studies,

and the individual practitioners should collect primary data to the largest extent possible for the case at hand.

#### 4.1 Electricity production

As seen in Table 13 for the electricity production, the *construction* stage dominates the overall material use, whilst the *operational* stage constitutes most of the use of natural resources such as groundwater (99 %) and geothermal fluid (100 %). Since only direct emissions from the use of geothermal fluid are accounted for in the LCI presented, a comparison between emissions from the different life cycle stages cannot be made. The drilling of make-up wells and laying of new collection pipelines during the *maintenance* stage results in 12–18 % of the overall use of cement (11 %), aluminum (12 %), steel (16 %), and mineral wool (18 %) while 20 % of the materials used mainly or primarily during drilling (diesel, bentonite, silica flour, and lignosulfonate) are used within the maintenance stage.

For the *construction* stage, the processes contributing the most to the overall use of the bulk materials and resources are visualized in Fig. 4. The highest contributions to the material,

**Fig. 4** Distribution of resource and material use in different sections during construction of the Hellisheiði GCHP plant

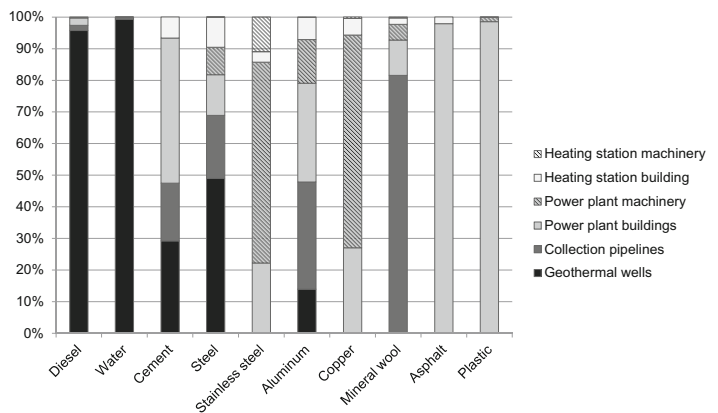

resource, and energy use for the different parts of the power plant are:

- Geothermal wells: diesel fuel (96 %), water (99 %), and steel (47 %)
- Collection pipelines: aluminum (38 %) and mineral wool insulation (84 %)
- Power plant buildings: cement (46 %), asphalt (98 %), and plastic (99 %)
- Power plant machinery: copper (67 %) and stainless steel (64 %)

The difference between the overall use of materials and resources in SF and DF setups is in most cases 12 % higher for the SF setup compared with the DF setup, representing directly the 12 % increased power output for the DF setup compared with the SF. In other cases where smaller increase is observed and even decrease in consumption for the SF setup compared with the DF, it is explained by the large material burdens of the LP unit in the DF setup as it requires similar amounts of materials for construction and machinery as well as auxiliary power demand as the HP units but produces less electricity.

#### 4.2 Heat production

Table 14 shows that, as for the electricity production, material burdens of the hot water produced are associated with the *construction* stage while use of natural resources and energy inputs are governed by the *operational* stage. The input of waste heat from the power station results in a factor of 1.7 MJ of waste heat needed to produce 1 MJ of usable heat for district heating.

#### 4.3 Potential contribution of transport of goods to site

The inventory presented for Hellisheiði GCHP excludes information on transport of goods to the power plant site during construction. To evaluate the possible contribution of transportation of goods to Hellisheiði, the fuel consumption was estimated. Shipping distances for materials and machinery from their country of origin (Japan, USA and central Europe) to Iceland and transportation distances by lorry to and from the harbors was estimated. The results show that transport by lorry to and from harbors increases the overall diesel fuel consumption by 3 % while shipping of goods from production site to Iceland account for an additional fuel consumption of 6 %. This estimation emphasizes that transportation can significantly contribute to the total fuel consumption in LCIs, particularly when shipping heavy goods by long distances. However, the significance in the LCA results may not necessarily be of importance.

## 5 Conclusions

The purpose of this study was to present a LCI for Hellisheiði GCHP plant as an input to the practice of LCA for the production of electricity and heat from geothermal energy conversion systems. Previous LCA studies and LCI compilations have focused on enhanced geothermal systems (EGS) and binary power plants, while flash power plants located in high-temperature geothermal fields account for the majority of electricity produced worldwide from geothermal resources.

Because geothermal power plants have to be designed and operated under site-specific conditions, the LCI presented in this study is either labeled as site specific data or scaled to a selection of site specific parameters identified for GCHP plants to make the data available as secondary data for LCA practitioners with the possibility of scaling data according to the conditions at hand. The site-specific parameters include number of wells and the total meters drilled per site, the length of collection pipelines, and the installed electrical and thermal capacity. For the operational and maintenance stages, the site-specific data include the need for make-up wells, composition, and mass flow of geothermal fluid from wells, groundwater needs, life time of the power plant, the power plants capacity factor, and auxiliary power demand, as well as the estimated total heat production in case of CHP plants. These are then the minimum data to be collected when performing LCAs of flash power plants, in cases where access to primary data is limited.

Finally, an aggregated LCI for Hellisheiði GCHP plant is given for presenting the material and energy burdens per functional unit of 1 kWh for electricity and 1 MJ of heat. It shows how the construction stage dominates the material burdens while the operational stage dominates the use of resources such as groundwater and geothermal fluid and the environmental burdens associated with these.

The compilation of LCI is in most cases the most time-consuming process of an LCA. The availability of published data representing the technology at hand can aid the practitioners of LCA to perform analysis of geothermal energy conversion systems or products or processes that use geothermal electricity and heat by minimizing the data collection requirements and thus saving both time and resources at hand. The inventory for Hellisheiði GCHP represents 61 % of the geothermal electricity produced worldwide, and the inventory for hot water production can serve as a basis for assessing the environmental burdens and benefits of the combined heat and power production in geothermal plants.

**Acknowledgments** The work is a part of the Primary Energy Efficiency (PEE) project that was funded by Nordic Energy Research and co-financed by Orkusjóður fund owned by the Government of Iceland and the Landsvirkjun Energy Research fund. Orkuveita Reykjavíkur supported the work by full access to data on the Hellisheiði GCHP plant along with expert advice. Mannvit and Verkis Consulting Engineers provided expert advice on data and process flow. Iceland Drilling and Iceland

GeoSurvey (ISOR) provided expert advice on data gaps for the geothermal drilling process. Special thanks to Einar Gunnlaugsson and other specialists at Orkuveita Reykjavíkur as well as Elin Hallgrímsdóttir at Mannvit for their extensive support. Ragnar Gylfason is acknowledged for his contribution to preliminary data gathering.

## References

- Bayer P, Rybach L, Blum P, Brauchler R (2013) Review on life cycle environmental effects of geothermal power generation. *Renew Sustain Energy Rev* 26:446–463
- Bertani R (2012) Geothermal power generation in the world 2005–2010 update report. *Geothermics* 41:1–29
- Cement Concrete & Aggregates Australia (2004) Assessing concrete volumes.
- Curran MA, Mann M, Norris G (2005) The international workshop on electricity data for life cycle inventories. *J Clean Prod* 13(8):853–862
- DiPippo R (2008) Geothermal power plants. Principles, applications, case studies and environmental impact. Elsevier
- Drysdale D (2010) Carbon footprint for the Tauhara stage II geothermal development project. The New Zealand forest research institute (SCION), Rotorua
- ecoinvent Centre (2007) ecoinvent data v2.0. Swiss Centre for Life Cycle Inventories. Dübendorf, retrieved from: [www.ecoinvent.org](http://www.ecoinvent.org)
- ecoinvent Centre (2013) ecoinvent data v3.0. Swiss Centre for Life Cycle Inventories. St. Gallen, retrieved from: [www.ecoinvent.org](http://www.ecoinvent.org)
- Frick S, Kaltschmitt M, Schroder G (2010) Life cycle assessment of geothermal binary power plants using enhanced low-temperature reservoirs. *Energy* 35(5):2281–2294
- Gerber L, Gassner M, Maréchal F (2011) Systematic integration of LCA in process systems design: application to combined fuel and electricity production from lignocellulosic biomass. *Comput Chem Eng* 35(7):1265–1280
- Giardini D (2009) Geothermal quake risks must be faced. *Nature*. Nature Publishing Group. doi:10.1038/462848a
- Gunnlaugsson E (2012) Hellið—Vinnuskýrsla 2011. Orkuveita Reykjavíkur, Reykjavík
- ISO (2006a) ISO 14040: Environmental management—life cycle assessment—principles and framework. International Organization for Standardization, Geneva
- ISO (2006b) ISO 14044: Environmental management—life cycle assessment—requirements and guidelines. International Organization for Standardization, Geneva
- Lazzaretto A, Tsatsaronis G (2006) SPECO: a systematic and general methodology for calculating efficiencies and costs in thermal systems. *Energy* 31(8–9):1257–1289
- Lo Rizzo S (2003) Environmental product Declaration. Power transformers 40/50 MVA (ONAN/ONAF). ABB, Milano
- Lund JW, Freeston DH, Boyd TL (2011) Direct utilization of geothermal energy 2010 worldwide review. *Geothermics* 40(3):159–180
- Orkuveita Reykjavíkur (2013) Vinnslurás Helliðarvirkjunar. <http://www.or.is/vinnsluras/>. Accessed May 15 2013
- Sullivan JL, Clark CE, Han JW, Wang MQ (2010) Life-cycle analysis results of geothermal systems in comparison to other power systems. Argonne National Laboratory
- Sveinbjörnsson BM, Thorhallsson S (2014) Drilling performance, injectivity and productivity of geothermal wells. *Geothermics* 50: 76–84
- Treyer K, Bauer C (2013) Life cycle inventories of electricity generation and power supply in version 3 of the ecoinvent database—part I: electricity generation. *Int J Life Cycle Assess* 1–19. doi:10.1007/s11367-013-0665-2
- Tsatsaronis G, Czielska F (2003) Thermoconomics. In: Meyers RA (ed) *Encyclopedia of physical science and technology*, 3rd edn. Academic Press, New York, pp 659–680



# Paper II

Karlsdottir, M. R., Heinonen, J., Palsson, H., & Palsson, O. P. (2020). Life cycle assessment of a geothermal combined heat and power plant based on high-temperature utilization. *Geothermics*, 84, 101727.







Contents lists available at ScienceDirect

## Geothermics

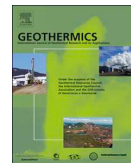
journal homepage: [www.elsevier.com/locate/geothermics](http://www.elsevier.com/locate/geothermics)

# Life cycle assessment of a geothermal combined heat and power plant based on high temperature utilization

Marta R. Karlsdottir<sup>a,\*</sup>, Jukka Heinonen<sup>b</sup>, Halldor Palsson<sup>a</sup>, Olafur P. Palsson<sup>a</sup><sup>a</sup> Faculty of Industrial Engineering, Mechanical Engineering and Computer Science, University of Iceland, VR-II Hjarðarhaga 6, 107 Reykjavík, Iceland<sup>b</sup> Faculty of Civil and Environmental Engineering, University of Iceland, VR-II Hjarðarhaga 6, 107, Reykjavík, Iceland

## ARTICLE INFO

## Keywords:

Life cycle assessment (LCA)  
 Geothermal energy  
 Combined heat and power plant (CHP)  
 Global warming potential (GWP100)  
 Carbon capture and storage (CCS)

## ABSTRACT

This study applies life cycle assessment (LCA) to examine environmental impacts of generating 1 kWh of energy in a geothermal combined heat and power (CHP) plant based on high temperature geothermal utilization. The Hellisheidi geothermal CHP plant located in SW Iceland, producing 303 MW<sub>e</sub> and 133–267 MW<sub>th</sub> in a double flash cycle, is used as a case study for the LCA. The CML-IA baseline and Cumulative Energy Demand (CED) methods are used to perform the life cycle impact assessment (LCIA), providing results for common environmental impact categories investigated in most LCA studies. The impacts associated with joint production processes for electricity and heat are allocated to the two products by energy allocation. The result show that the construction phase of the plant, mainly drilling and casing of geothermal wells along with construction of collection system for geothermal fluid, is largely responsible for most of the impact category results. However, the *global warming potential* (GWP100), *acidification* (AP) and the *renewable cumulative energy demand from wind, solar and geothermal energy* (CED<sub>R,w,s,g</sub>) are mainly affected by the operational phase of the plant, due to direct emissions of gases (mainly CO<sub>2</sub> and H<sub>2</sub>S) and the extraction of geothermal fluid from ground. To explore the effects of currently installed mitigation methods and operational improvements at the Hellisheidi plant, two operation scenarios are investigated within the study; the first based on a previously published dataset for operating conditions at year 2012 and the second, an updated dataset based on inclusion of implemented mitigation methods until the operating year 2017. Due to carbon capture and storage (CCS) by reinjection of CO<sub>2</sub> using the CarbFix method developed at Hellisheidi, the GWP100 reduced from 15.9 g CO<sub>2</sub>eq/kWh to 11.4 g CO<sub>2</sub>eq/kWh for electricity and 15.8 g CO<sub>2</sub>eq/kWh to 11.2 g CO<sub>2</sub>eq/kWh for heat over the 30-year operational time under investigation. Similarly, the SulFix method used for reinjection of H<sub>2</sub>S at Hellisheidi resulted in decreased AP from 9.7 g SO<sub>2</sub>eq/kWh to 3.6 and 3.5 g SO<sub>2</sub>eq/kWh and *human toxicity* (HTP) from 5.8 and 5.5 g 1,4-DB eq/kWh to 5.1 and 4.8 g 1,4-DB eq/kWh for electricity and heat respectively. The overall CED resulted in 5.2 kWh (18.7 MJ) of energy demand to produce 1 kWh of either electricity or heat, dominated by the use of geothermal energy as mentioned earlier. Non-renewable energy demand (CED<sub>NR</sub>) decreased from 6.8 × 10<sup>-3</sup> and 5.9 × 10<sup>-3</sup> kWh (0.024 and 0.021 MJ) to 5.8 × 10<sup>-3</sup> and 5.0 × 10<sup>-3</sup> kWh (0.021 and 0.018 MJ), for electricity and heat respectively, by using electrical drills instead of diesel fueled drills for additional wells during the operational time of the power plant. In conclusion, these results indicate a very high environmental performance of the Hellisheidi plant compared to other energy conversion technologies and emphasizes the potential of geothermal energy as a clean energy source for producing electricity and heat.

## 1. Introduction

Geothermal energy is defined as a renewable resource by the International Panel of Climate Change (IPCC) if the utilization rate is in balance with the natural recharge rate of heat and fluid to the geothermal reservoir (Goldstein et al., 2011). It is typically a low emitting resource compared to conventional energy resources, but some gaseous atmospheric emissions are an inevitable part of most geothermal power

plant operations. In deep geothermal reservoirs, where hot fluid interacts with the surrounding rock, gases and various minerals are dissolved within the geothermal fluid. When the fluid is brought to the surface, these gases are either released to the atmosphere or treated with an abatement method. The type and amount of gasses may vary greatly between different geothermal fields. These gases are mainly CO<sub>2</sub>, H<sub>2</sub>S and CH<sub>4</sub> along with various trace gases. A study by Bertani and Thain (2002) reports values for direct CO<sub>2</sub> emissions from the

\* Corresponding author.

E-mail address: [mrk1@hi.is](mailto:mrk1@hi.is) (M.R. Karlsdottir).

<https://doi.org/10.1016/j.geothermics.2019.101727>

Received 5 January 2019; Received in revised form 16 August 2019; Accepted 4 September 2019

Available online 14 November 2019

0375-6505/ © 2019 Elsevier Ltd. All rights reserved.

operation of geothermal power plants ranging from 7 to 740 g/kWh with a weighted average value of 122 g/kWh. In a special report of the IPCC on Renewable Energy Sources and Climate Change Mitigation, a review of published values for life cycle emissions of geothermal power generation showed values in the range 6–79 g/kWh (Moomaw et al., 2011). By comparison, reported values of life cycle GHG emissions for conventional fossil fuel generation plants are in range 833–1,297 g/kWh for coal fired plants, 386–605 g/kWh for gas fired and 641–1,462 g/kWh for oil fired plants (Hussy et al., 2014).

Iceland is one of the leading countries in geothermal utilization. It fulfills around 62% of its total primary energy demand with the use of geothermal resources (National Energy Authority, 2017b). For heating purposes alone, hot water produced from geothermal resources serves 96% of the country's heating demand. In addition, a total of 27.3% of the electricity demand is produced in geothermal power plants (National Energy Authority, 2017a). In 2018, 755 MW of installed power capacity was available from geothermal resources in Iceland and the country still has large unexploited geothermal potential. The Master Plan for Nature Protection and Energy Utilization passed by the Parliament of Iceland in 2014 includes 14 geothermal projects with an expected total electric capacity of roughly 1000 MW that have been categorized as feasible for further power generation in terms of both economic implications and their environmental consequences (2nd Master Plan Steering Committee, 2011). An updated Master Plan for Iceland is expected in 2021 (The Master Plan for Nature Protection and Energy Utilization, 2017).

When comparing different energy technologies with respect to their impact on the environment and use of finite energy and material resources, it is important to do so holistically to avoid hidden impacts in upstream or downstream processes. The popularity of using life cycle assessment (LCA) as a tool to evaluate the environmental impacts of products, processes and services in a holistic manner throughout their entire life cycle is steadily increasing (Hellweg and Milà i Canals, 2014). The method of LCA can give important information on substantial impacts that can occur before or after the operational phase of power plants. LCA studies have already identified environmental impacts associated with renewable energy technologies that occur prior to their (often zero-emitting) operational phase (Varun Bhat and Prakash, 2009), that shed an important light on potential manufacturing or construction improvements that can be made on their installations.

Previous studies that publish life cycle assessment results for geothermal power generation have mainly focused on low- to medium-temperature utilization using binary cycle technologies for power production. In a recent review by Tomasini-Montenegro et al. (2017), LCA studies on energy production from geothermal sources were presented. They specifically mention the scarcity of LCA studies focusing on flashing technologies in the geothermal sector, although these technologies are responsible for 63% of the world's installed geothermal power capacity. A former review by Bayer et al. (2013) also pointed out the scarcity of LCA studies for geothermal energy production in general. Between the publication of those two review studies, numerous scientific publications regarding LCA and geothermal utilization have been made, making it evident that LCA methodology is gaining interest within the geothermal sector. Amongst the newest published studies, Hanbury and Vasquez (2018) apply a stochastic approach in their LCA study to allow for variations in the life cycle inputs to a modern geothermal binary power plant located in northern Nevada, USA. They find that most environmental impacts are associated with the use of fossil fuels for drilling and transportation in the construction phase of the plant, since practically no direct emissions stem from the binary power plant in question during operation. This is, however, not true for high-temperature geothermal power plants using flash or dry steam technology. Buonocore et al. (2015) performed LCA on a 20 MW dry steam power plant in Tuscany, Italy. The study used the CML 2001 and Cumulative Energy Demand (CED) methods to perform the life cycle impact assessment (LCIA). It reports GWP of 248 g CO<sub>2</sub> eq/kWh and total

CED of 25.6 MJ/kWh (7.1 kWh/kWh) and non-renewable CED of 0.8 MJ/kWh (0.2 kWh/kWh) with more than 99% of the CED referring to the input of geothermal energy in the operational phase of the power plant. They also report the contribution of decommissioning and disposal of power plants and find them to be neglectable. Similar findings on the difference between the contribution of different life cycle phases to the overall GHG emissions from geothermal binary plants and high-temperature flash plants are reported in a systematic review on published life cycle GHG emissions from geothermal electricity generation, made by the US Department of Energy National Renewable Energy Laboratory (NREL), (Eberle et al., 2017). The report further highlights that studies on flash technologies (Hondo, 2005; Karlsdóttir et al., 2010; Marchand et al., 2015; Martínez-Corona et al., 2017; Skone et al., 2012; Sullivan et al., 2014; Sullivan and Wang, 2013) generally produce higher GHG emissions per kWh than binary technologies due to the release of non-condensable gases during operation of flash plants while binary plants operate in a closed-loop system.

The aim of this study is to assess the life cycle environmental impacts of a high-temperature geothermal power plant using flashing technology. Additionally, it aims to showcase how effectively mitigation methods can reduce the environmental impacts of geothermal power plants. The study presents LCA results for the production of electricity and heat from the largest geothermal power plant in Iceland, the 303 MW<sub>e</sub> and up to 267 MW<sub>th</sub> (current planned thermal capacity within the time frame of this study) Hellisheidi geothermal combined heat and power (CHP) plant. The operation of the plant has undergone some changes during recent years to incorporate mitigation methods such as to lower the direct emissions of non-condensable gases from the plant. The study presents a comparison of results between the originally designed operational setup of the plant versus the current operational setup that includes the implemented mitigation measures. The results show that the mitigation measures have substantially reduced the plant's environmental impacts in various categories. Furthermore, the study takes a step towards filling the gap in literature on LCA studies on geothermal power plants using flash-steam technology and adds to the range of results for different impact categories as these can be heavily site specific for geothermal heat and power production.

In the following sections, the methods, goal and scope of the study is presented in detail, followed by the results and conclusions of the study. Also, a supplementary section is available and referred to for further in-depth discussion on different results and methods.

## 2. Methods, goal and scope

The present LCA study follows the framework, principles, requirements and guidelines given by the International Organization for Standardization as described in the standards ISO 14040:2006 and ISO 14044:2006. The following subsections discuss the four phases of the study, namely the definition of goal and scope, life cycle inventory (LCI) analysis, life cycle impact assessment (LCIA), and interpretation of results.

### 2.1. Goal and scope

The goal of the LCA is to investigate the environmental impacts of a geothermal power plant that uses flashing technology to produce energy from a high-temperature geothermal resource. The Hellisheidi geothermal CHP plant, located in South-West Iceland, was chosen as a case study to fulfill this goal as it is state of the art and the largest of its type world-wide, producing both electricity as well as heat for district heating purposes. Furthermore, the LCA results allow for investigating the contribution of different life cycle stages of high-temperature geothermal heat- and power production to the overall environmental impacts of the energy produced, contributing to research on the life cycle impacts of renewable energy technologies that in some cases have higher environmental load in their construction phase than in their

operational phase (as opposed to fossil fueled technologies due to fuel combustion).

Lastly, the study investigates the effects of operational improvements made on the Hellisheidi CHP plant since the plant was fully operational (in terms of installed electrical capacity) in 2012 to the year 2017. To do that, the study investigates two sets of LCI's; (1) a base case inventory representing operational conditions of 2012 as published by Karlsdottir et al. (2015), and (2) an updated inventory representing operating conditions of 2017 by inclusion of implemented operational improvements (such as mitigation of direct emissions). The comparison of the two inventories shows how proper abatement methods can substantially improve the life cycle environmental performance of high-temperature geothermal plants.

2.1.1. Description of the product system: the Hellisheidi geothermal CHP plant

The Hellisheidi geothermal plant is a double flash CHP plant with 303.3 MW of installed electric production capacity (6 × 45 MW high pressure turbines and 1 × 33.3 MW low pressure turbine). Furthermore, it presently has 133 MW<sub>th</sub> of installed thermal production capacity for district heating purposes with planned capacity of 267 MW<sub>th</sub> within the modelled 30-year operational time in this study (and thus included in the LCA) and possibilities for up to 400 MW<sub>th</sub> capacity in future expansions. A schematic representation of the CHP plant is given in Fig. 1. To produce electricity and heat, the CHP plant utilizes geothermal fluid from multiple deep wells located within a production zone surrounding the plant. The fluid is a saturated mixture of steam and liquid (referred to as brine) and is led towards the CHP plant in insulated steel pipelines. Before entering the plant, the brine is separated from the steam and the saturated steam is then led towards high-pressure turbines to generate electricity. The generation of electricity is performed in two separate pressure stages; high-pressure, represented by blue components in Fig. 1 and low-pressure, represented by green components. The saturated brine is led towards the low-pressure unit, where the pressure is dropped resulting in boiling and generation of additional steam for the low-pressure turbine. The rest of the brine is then utilized to heat groundwater for the hot water (heat) production that serves the capital area of Reykjavik with a large share of its heating demand. This cascaded use of the geothermal fluid allows for a more efficient use of the resource than in most other geothermal power plants only producing electricity from high-pressure steam.

2.1.2. Choice of functional units

Hellisheidi geothermal CHP plant produces two separate products and thus has two main functions; generation of electricity and production of hot water for district heating. Thus, there are two functional units to be specified for the product system. It is common practice to use 1 kWh of electricity as the functional unit for electricity generation, and either 1 MJ (e.g. Burchart-Korol et al. (2016); Frick et al. (2010)) or 1 kWh (e.g. Karlsson et al. (2018); Ristimäki et al. (2013)) of heat for the production of district heat.

In this study, the unit 1 kWh is chosen to represent the function of the two products. Despite their common unit, the two products have very different functions that must be emphasized:

- 1 kWh of electricity represents the net generated electricity from Hellisheidi geothermal CHP plant that is supplied to the national power grid. All parasitic loads have been subtracted from the total generated electricity within the CHP plant and allocated to the specific product according to physical relationships.
- 1 kWh of heat represents the usable heat content within the hot water produced at Hellisheidi. The usable heat is based on the commonly used (simplified) assumption for Icelandic district heating systems with supply temperature of 80 °C and return temperature of 40 °C, that is an average temperature difference in household radiators of 40 °C. This temperature difference is used to calculate the usable heat content of the hot water produced at the CHP plant in terms of kWh.
- It should be noted that 1 kWh of electricity is not comparable to 1 kWh of heat in terms of thermodynamic definition of energy quality (exergy). 1 kWh of usable heat cannot be used to replace the energy demand for 1 kWh of electricity unless the demand is for heating purposes only.

2.1.3. Description of system boundary

The system boundary is described with the process flow diagram in Fig. 2. The elementary and product flow in and out of the system, that serve as inputs to the different unit processes, are shown on the top and bottom. The independent unit processes needed to produce electricity and heat are presented within the two intact boundaries. The multifunctional (joint) unit processes, meaning that they serve the production of both products (electricity and heat), are presented within the slotted line boundary and are the following:

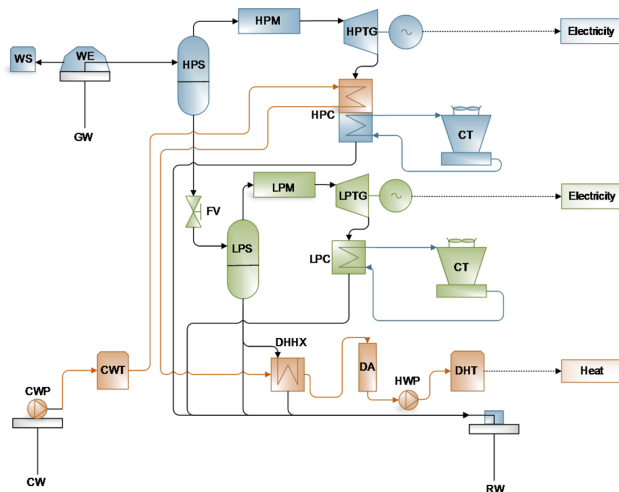

WS	Well silencer
WE	Wellhead
GW	Geothermal well
HPS	High pressure steam separator
HPM	High pressure moisture remover
HPTG	High pressure turbine-generator set
HPC	High pressure condenser with preheater
CT	Cooling tower
FV	Flashing valve
LPS	Low pressure steam separator
LPM	Low pressure moisture remover
LPTG	Low pressure turbine-generator set
LPC	Low pressure condenser
CW	Cold water well
CWP	Cold water pumps
CWT	Cold water tank
DHXX	Heat exchanger District Heat
DA	Deaerator
HWP	Hot water pump
DHT	Hot water tank District Heat
RW	Reinjection well

Fig. 1. Schematic of the Hellisheidi geothermal CHP plant.

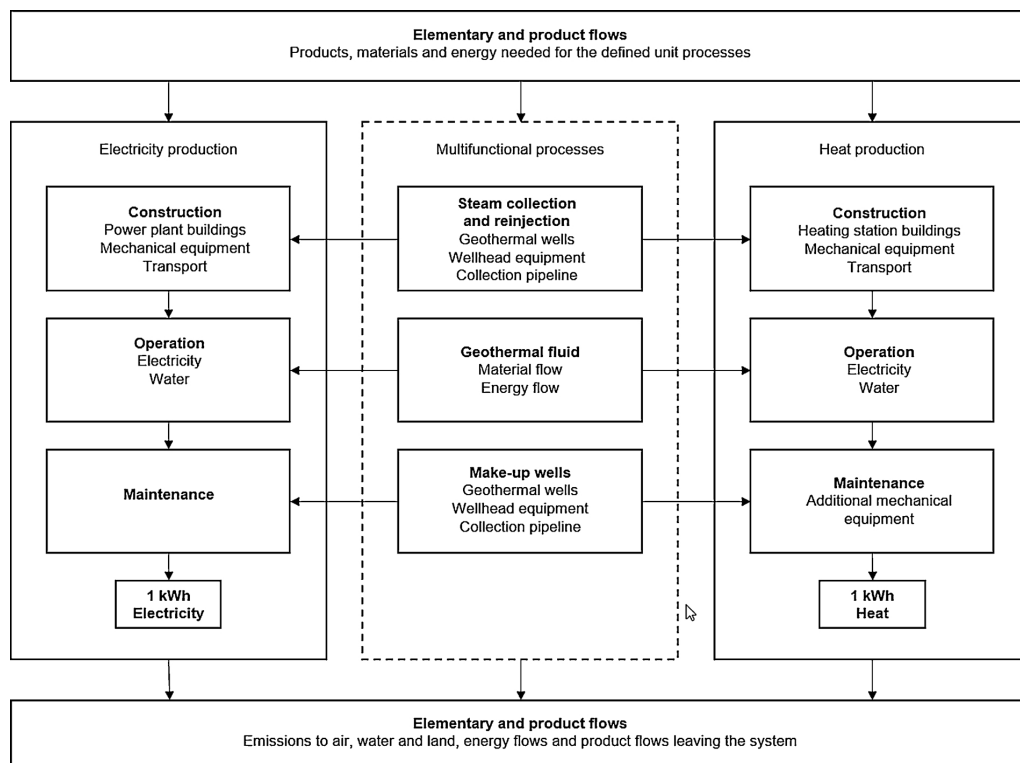

Fig. 2. The main unit processes set up to describe the production of electricity and heat from Hellisheiði geothermal CHP plant.

- 1 **Steam collection and reinjection system** that acquire, transport and dispose of the extracted geothermal fluid for the production processes. This includes initial drilling of wells for the commission of the CHP plant.
- 2 The use of **geothermal fluid**, with its energy content serving as an energy input for the conversion cycle and the included gas content causing various environmental effects.
- 3 The drilling of **make-up wells** for maintaining energy supply during the lifetime of the CHP plant.

To assign the environmental impacts of these multifunctional processes to the production of electricity and heat at Hellisheiði CHP plant, an allocation method must be applied as described in Section 2.1.4.

The time horizon chosen for the study is 30 years of operation, corresponding to a commonly used assumption of a 30-year technical lifetime of power plants in other LCA studies (Frick et al., 2010; Hanbury and Vasquez, 2018; Hondo, 2005; Marchand et al., 2015). However, the three oldest geothermal power plants in Iceland have surpassed 30 years of operation, the oldest one at Bjarnarflag in Northern Iceland dating back to 1963 (Júliússon and Axelsson, 2018), and those plants still have some of their original equipment operational. Evidence thus show that technical lifetime of geothermal power plants can be estimated to surpass a 30 year lifetime, and some studies even suggest a life time of 100 years for geothermal production (Martinez-Corona et al., 2017; Rule et al., 2009). Even though equipment lifetime can be prolonged over the common assumption of 30 years with appropriate maintenance, it is non the less likely that many geothermal plants upgrade their equipment after a few decades of operation due to advances in technology or changes in the characteristics of the geothermal resource that require energy system upgrades. Thus, an

operational time of 30 years is assumed to be a relevant choice in this study for the Hellisheiði CHP plant without considering renewal of mechanical equipment.

No transmission losses are considered since the electrical grid is outside the system boundary. For the same reasons, thermal losses in the distribution of heat to households are not included in this study. This study is therefore considered “cradle-to-gate”.

#### 2.1.4. Choice of allocation method

Allocation of environmental impacts between products from co-production processes, to share the burdens in a reasonable and fair way, is a well-known problem within LCA. Combined heat and power (CHP) plants, such as the Hellisheiði plant, are a good example of such co-production processes that face an allocation dilemma. As is common for other co-production processes, no consensus has been reached on how to allocate environmental impacts between electricity and heat produced in CHP plants (Heinonen et al., 2015). The International Organisation of Standardisations (ISO) gives general recommendations on allocation in the ISO 14040 standard that are open to many different choices (ISO 14040, 2006). Specific methods are given for the allocation problem of CHP plants by the International EPD System in a set of product category rules according to ISO 14025 on electricity, steam and hot/cold water generation and distribution (The International EPD System, 2015). That method is based on system expansion, where the burdens of each product are assigned according to their share of avoided impacts if these two products (electricity and heat) have been produced separately. The method is easily applicable for CHP systems that are replacing other common forms of separate electricity and heat production technologies. But for Icelandic conditions, where geothermal CHP plants are among the most common technology used, it is

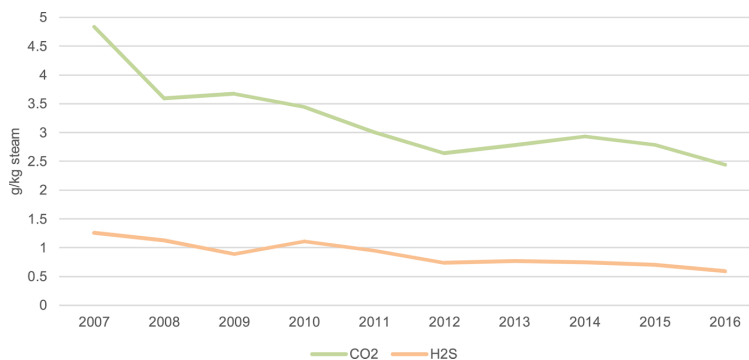

Fig. 3. The variation of dissolved CO<sub>2</sub> and H<sub>2</sub>S in geothermal steam at Hellisheidi CHP plant from 2007 to 2016 (Data from Reykjavik Energy).

of little concern to estimate share of avoided impacts from other technologies.

For Hellisheidi CHP plant, both the production of electricity and heat are vital to the plant owners. The plant was built to meet the steady increase in demand of district heat in the capital area for the foreseeable future and to produce electricity for Icelandic industries, businesses and homes. During cold spells, electricity production at the plant may be temporarily reduced to meet the peak in heat demand even though the overall aim of the plant is to maximize its electricity production as the price of electricity is generally higher than price of heat. Thus, one might conclude that the importance of these two products are equally high for the project stakeholders and decision makers. A selection of allocation method should thus agree with that statement and distribute the environmental impacts associated with the production fairly between the two products. For this study, allocation based on energy production was chosen. The inputs of the multifunctional processes were thus divided between the two products based on their share of usable energy produced by the plant. The share of produced electricity in the total useful energy production of the Hellisheidi plant is estimated to be around 73% over the 30-year operational time in question, while the share of useful heat is around 27%.

## 2.2. Base case life cycle inventory – 2012 LCI

The base case life cycle inventory, named “2012 LCI” since it was designed to represent operational data from 2012, was compiled by using primary data from the power plant operator (also the project developer) and designers, and secondary data from the ecoinvent v3.4 database. The 2012 LCI has been published in detail in a separate study by Karlsdóttir et al. (2015) to serve as a reference or secondary data for others to use in screening LCA studies on high-temperature flash geothermal power plants. The inventory is used in this study to serve as the base case scenario for the LCA on Hellisheidi CHP plant.

For the production of heat, the forecasted increase in heat demand throughout the 30-year operational time modelled for the plant is considered, which predicts that the capacity of the heating station will be doubled within the timeframe requiring additional mechanical equipment.

One significant modification was made on the previously published inventory regarding the amount of make-up wells needed for sustaining power production over the lifetime of the plant. In this study, the average amount of make-up wells was estimated to be one drilled per year, or 30 wells drilled in total during 30 years of operation, as opposed to drilling a well every second year (15 wells in total) as the inventory study suggested. The reason is that the operational experience of the plant in the recent years has suggested the need for expanding the production field (Gunnarsson and Mortensen, 2016) that requires the drilling of more make-up wells than stated in the

environmental impact assessment of the current plant (VGK consulting, 2005).

## 2.3. Updated life cycle inventory – 2017 LCI

Major improvements have been made on the operation of Hellisheidi power plant since the compilation of the 2012 LCI described in Section 2.2. The biggest changes to the 2012 LCI are the following:

- 1 Natural variations in the gas content of the geothermal fluid.
- 2 Use of innovative mitigation methods of geothermal gas emissions, known as the CarbFix and SulFix projects.
- 3 Use of electrical drill rigs instead of diesel fueled rigs for drilling make up wells.

To account for those changes, an update on the operational (gas content and mitigation methods) and maintenance (drilling) data of the base case inventory was made, named 2017 LCI. Only two processes from Fig. 2 were modified in the updated LCI; namely the “Make-up wells” to account for electrical drilling and the “Geothermal fluid” to account for changes in gas content as well as the new emission mitigation methods. The modifications are discussed briefly below.

### 2.3.1. Natural variations in gas content

During utilization of geothermal energy, it is likely that the amount of gas dissolved in geothermal fluid changes over time. Fig. 3 shows how the amount of CO<sub>2</sub> and H<sub>2</sub>S per kg of steam changed at the Hellisheidi plant during the production period of 2007–2016. The gas content decreases more rapidly in the first few years of production, while a slow decrease is seen in the recent years. The decrease in gas content can be due to variation in which wells are used for production at each time or degassing of the geothermal resource due to the extraction of geothermal fluid. To account for natural variations, the available measurement for 2012–2017 were included in the updated LCI and the gas content from 2017 to the end of the 30-year operational time assumed to be fixed at 2017 values, resembling steady state conditions.

### 2.3.2. Implemented mitigation methods – CarbFix and SulFix

In 2007, a research project referred to as CarbFix was initiated to develop a method for carbon capture and storage (CCS) by injecting CO<sub>2</sub> into basaltic rocks that are commonly found in Icelandic bedrock. The Hellisheidi area was used as a site for pilot reinjection tests, which proved to be successful in mineralizing CO<sub>2</sub> into the basaltic bedrock. The method was further developed for reinjection of hydrogen sulphate (H<sub>2</sub>S), now referred to as the SulFix method, as the emissions from the CHP plant had resulted in a significant increase in H<sub>2</sub>S levels in the capital region of Reykjavík and mitigation methods were needed to

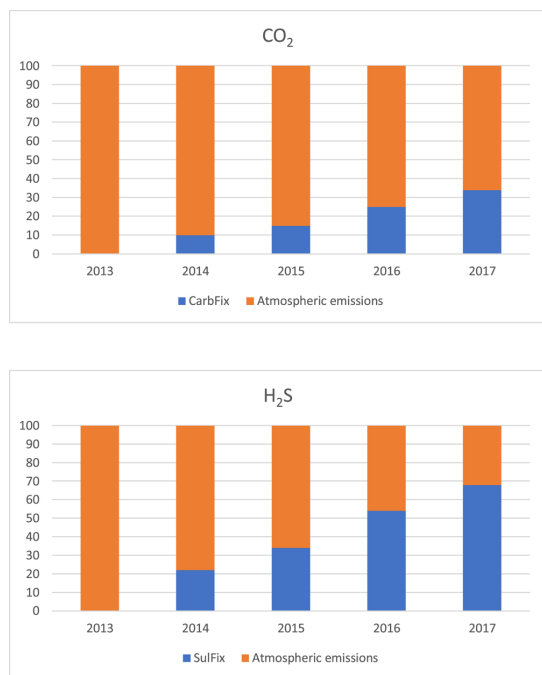

Fig. 4. The proportional amount of CO<sub>2</sub> and H<sub>2</sub>S from Hellisheidi power plant that was reinjected with the CarbFix and SulFix methods in the years 2013–2017 (Sigfússon et al., 2018).

comply with regulations on H<sub>2</sub>S levels in Iceland (Aradóttir et al., 2015). The CarbFix method has proven to be much more efficient than other traditional CCS methods, with 95% of the CO<sub>2</sub> being mineralized within 2 years of reinjection opposed to hundreds or thousands of years for conventional CCS methods (Matter et al., 2016). Both the CarbFix and SulFix methods have been reported as potentially more cost effective than other known CCS methods for these gaseous emissions. Gunnarsson et al. (2018) reported a total cost of 25–50 USD/ton of CO<sub>2</sub>-H<sub>2</sub>S mixture captured and stored by the developed methods at Hellisheidi in comparison with 38–143 USD/ton CO<sub>2</sub> for other reported CCS methods and costs exceeding 300 USD/ton for H<sub>2</sub>S abatement. However, the authors of the study point out that the application of CarbFix and SulFix is site specific and the cost dependent on factors such as gas composition, depth of storage reservoir and local energy costs.

Since 2014, these methods have been used on an industrial scale at Hellisheidi to reinject both CO<sub>2</sub> and H<sub>2</sub>S from the plant, resulting in a

significant decrease of atmospheric emissions from the power plant (Sigfússon et al., 2018). Fig. 4 shows the proportion of CO<sub>2</sub> and H<sub>2</sub>S that has been reinjected since 2013. As of 2017, 34% of the CO<sub>2</sub> and 68% of the H<sub>2</sub>S reaching the surface with the geothermal fluid was reinjected back into the reservoir, resulting in corresponding reduction of atmospheric emissions.

### 2.3.3. Replacing diesel fueled drilling rigs with electrically powered rigs

Geothermal plants rely on multiple geothermal wells for their operation. They are drilled during resource identification and construction phases as well as during the operation/maintenance phase since make-up wells need to be drilled regularly to sustain steam flow for energy production, often due to a steady pressure drop in the geothermal reservoir and in some cases declining productivity of wells due to scaling. These wells are large, underground constructions that are drilled with heavy drill rigs, often fueled by diesel fuel and corresponding environmental impacts.

A large amount of the diesel fuel used during the lifetime of Hellisheidi CHP plant is due to drilling of wells. In the 2012 LCI, all wells prior to that year had been drilled with diesel fueled rigs. Also, all future geothermal make-up wells were assumed to be drilled with diesel fuel. However, the power plant has recently announced that new wells at the Hellisheidi site will be drilled using electrically powered drilling rigs to increase the environmental performance of the plant (ON Power, 2017). A study by Menberg et al. (2016) on LCA of EGS plants concludes that by using electricity from environmentally friendly resources or directly from the power plant, instead of using diesel fuel for drilling initial and make-up wells, significant improvements can be achieved in the environmental impact results. To account for these changes in drilling technology for the Hellisheidi CHP plant, the LCI was updated by changing the energy input for the drilling process of make-up wells from diesel fuel to electricity produced at plant.

### 2.4. Life cycle impact assessment (LCIA) method

For the LCIA, the SimaPro 8 software was used for data analysis and ecoinvent v3.4 database for secondary data (ecoinvent Centre, 2013) along with the inventory dataset from Karlsdóttir et al. (2015) and modifications mentioned in Section 2.2 and 2.3. The chosen methods for the impact assessment were CML-IA baseline (Guinée et al., 2002) and CED (Hischier et al., 2010). The CML-IA baseline method elaborates on the problem-oriented (midpoint) approach and includes 10 environmental indicators used in most LCAs. The CED method calculates the total use of energy resources divided into 5 impact categories. An overview of the different impact categories included in these two methods is shown in Tables 1 and 2 (Adapted from PRé (2018)). An overview of the selected input and output processes from ecoinvent (and other databases) for the LCA modelling of Hellisheidi in SimaPro is given in the supplementary information section of this paper.

Table 1  
Overview of the Impact assessment categories in the CML-IA baseline (v3.05) method.

Impact category	Abbreviation	Addresses
Depletion of abiotic resources	ADP	ADP has two impact categories in the method; Abiotic depletion (elements, ultimate reserves) relating to the extraction of minerals, expressed in kg antimony equivalents, and abiotic depletion (fossil fuels) relating to the extraction of fossil fuels expressed in MJ.
Acidification (modified)	AP	Acidifying substances emitted to air expressed in kg SO <sub>2</sub> equivalents. Modified in this study to include effects of H <sub>2</sub> S emissions.
Eutrophication	EP	Impacts due to excessive levels of macro-nutrients in the environment, expressed in kg PO <sub>4</sub> equivalents.
Climate change	GWP100	Emissions of greenhouse gasses to air expressed in kg carbon dioxide equivalents.
Stratospheric ozone depletion	ODP	Ozone depletion potential of different gasses expressed in kg CFC-11 equivalents.
Human toxicity	HTP	Effects of toxic substances on the human environment, expressed as 1,4-dichlorobenzene equivalents.
Fresh water aquatic ecotox.	FAETP	Effects of toxic substances on fresh water ecosystems, expressed as 1,4-dichlorobenzene equivalents.
Marine aquatic ecotoxicity	MAETP	Effects of toxic substances on marine ecosystems, expressed as 1,4-dichlorobenzene equivalents.
Terrestrial ecotoxicity	TETP	Effects of toxic substances on terrestrial ecosystems, expressed as 1,4-dichlorobenzene equivalents.
Photo-oxidant formation	POCP	Summer smog, or formation of reactive substances injurious to human health and ecosystems, expressed in kg ethylene equivalents.

**Table 2**

Overview of the different types of renewable and non-renewable energy resources, which use is estimated with the Cumulative Energy Demand (CED, v1.10) method.

Impact category	Abbreviation	Addresses
Non-renewable, fossil	CED <sub>NR,fossil</sub>	Cumulative energy use based on upper heating value of various fossil fuel resources.
Non-renewable, nuclear	CED <sub>NR,nuclear</sub>	Cumulative energy use based on energy value of natural uranium and a nuclear fuel chain modelled in ecoinvent v3.4.
Non-renewable, biomass	CED <sub>NR,bio</sub>	Cumulative energy use based on upper heating value of wood from primary forest.
Renewable, biomass	CED <sub>R,bio</sub>	Cumulative energy use based on upper heating value of wood from sustainable resources, food products, agricultural by-products etc.
Renewable, wind, solar, geothermal	CED <sub>R,s,w,g</sub>	Cumulative energy use based on converted solar energy, kinetic energy of wind and amount of geothermal energy delivered to a heat pump. Also considers the geothermal energy input to Hellisheidi geothermal power plant.
Renewable, water	CED <sub>R, water</sub>	Cumulative energy use based on the converted potential energy (rotation energy) of the water in a hydropower reservoir.
Total	CED <sub>total</sub>	Single score result for CED, a sum of all CED categories above.

For the sake of this study, a modification of the CML-IA baseline method was performed to include the acidification potential of H<sub>2</sub>S, as the unmodified baseline method does not include the effects of H<sub>2</sub>S. The reason why H<sub>2</sub>S is not included in the baseline method is because the characterization factor developed to transform H<sub>2</sub>S into SO<sub>2</sub> equivalents does not include a fate model, which was a prerequisite for the selection of characterisation factors to be used in the method. Due to the significant emission of H<sub>2</sub>S from Hellisheidi geothermal CHP plant, the baseline method was modified in this study to take the effects of the gas into consideration by applying the characterization factor used in the non-baseline method of CML-IA.

### 3. Life cycle impact assessment (LCIA) results

The results from the LCIA are presented in Section 3.1 for each impact category analyzed with the chosen LCIA methods discussed in Section 2.4. Normalization of the results is presented in Section 3.2 to communicate the relative significance of the results.

Furthermore, a more detailed discussion on each impact category result and uncertainty analysis with Monte Carlo can be found in the supplementary information section of this study.

#### 3.1. Impact category results for CML-IA and CED methods

The results from the LCIA for the production of heat and electricity are given in Table 3 for both operating scenarios (2012 and 2017). Due to the allocation method selected and the large impact of multifunctional processes to the overall results, similar results are retrieved based on the functional units of both products. The small differences can be explained by the different processes that are not multifunctional and thus assigned solely to either product. In all cases, the impacts of 1 kWh of electricity is slightly higher than of 1 kWh of usable heat due to the more extensive machinery needed for the production of electricity compared to production of hot water. Additionally, the comparison of LCIA results between the different operating scenarios shows a significant reduction within many LCIA categories as shown in Table 3 and discussed further below.

To further highlight the main contributors to the LCIA results, the relative contributions of the unit processes (as described in Fig. 2) are shown in Fig. 5 for the electricity production and in Fig. 6 for heat production. For simplicity reasons, results are only shown for the 2012 LCI but differences in process contributions in the 2017 LCI is explained instead in Fig. 8. The figures show that the three multifunctional processes are the biggest contributors to all impact categories, namely; the construction of the steam collection and reinjection systems, the drilling of make-up wells during maintenance and the use of geothermal fluid during operations. The first two mentioned processes both represent the same activities, namely the drilling and casing of geothermal wells and construction of collection pipelines, but they occur during different life cycle stages of the power plant (construction and operation respectively). They are the biggest contributors to all impact categories except for global warming potential (GWP100), acidification (AP) and the renewable cumulative energy demand from wind, solar and geothermal energy

(CED<sub>R,w,s,g</sub>). Their contribution is mainly due to production or use of diesel fuel and production of steel needed for the drilling and completion of geothermal wells. The main difference between the process contributions to the electricity and heat production in Figs. 5 and 6 is the larger share of mechanical equipment in the environmental impact results for electricity production while building infrastructure holds a larger share for the heat production. The mechanical equipment for the heat production mainly consists of heat exchangers and pumps, while equipment required for electricity production is far more extensive.

Direct emissions of geothermal gasses and the geothermal energy extraction connected to the use of geothermal fluid are responsible for the largest share of the impact categories that are not dominated by the drilling and infrastructure of geothermal wells mentioned above. The emissions of CO<sub>2</sub> and CH<sub>4</sub> hold the largest share of the GWP100, while emission of H<sub>2</sub>S is almost solely responsible for the AP. It is also worth mentioning that emission of H<sub>2</sub>S is responsible for a substantial share of the human toxicity (HTP) results and CH<sub>4</sub> also contributes to photochemical oxidation potential (POCP). The energy content of the geothermal fluid dominates the renewable cumulative energy demand from wind, solar and geothermal energy (CED<sub>R,w,s,g</sub>), as expected since the geothermal energy content of the fluid is used as a fuel for the electricity and heat production.

As can be seen from Table 3, the assessment of the updated 2017 LCI shows beneficial results in all impact categories for the production at Hellisheidi CHP plant. This is due to the overall reduction in emissions of geothermal gasses compared to the 2012 LCI, as well as the decrease in use of diesel fuel due to using electricity for drilling make-up wells. Fig. 7 shows the relative changes in LCIA results for the impact categories with changes of less than 1% excluded. The results show similar reductions for both electricity and heat. Fig. 8 furthermore shows the relative reduction of process contribution of the two processes that were affected by the updated 2017 LCI; namely "Make-up wells" and "Geothermal fluid" as explained in sec. 2.3. The relative reduction of process contribution was the same for both electricity and heat. The most significant change in overall impact results, according to Fig. 7, can be seen for acidification potential (AP) due to the extensive reinjection of H<sub>2</sub>S using the SulFix method. This has resulted in over 60% average reduction of H<sub>2</sub>S emissions over the 30-year operational time modelled for the CHP plant. Due to same reasons, the HTP is reduced by 12–13%, a smaller overall reduction compared to AP due to other processes (not affected by the update) contributing significantly to the overall HTP results. Also, due to significant reduction of CO<sub>2</sub> emissions with the CarbFix method, the GWP100 is reduced by almost 30%. The decrease in use of diesel fuel for drilling has resulted in reduction of ADP<sub>fossil</sub>, ODP, POCP, EP and CED<sub>fossil</sub>.

Section S.1 in the Supplementary material further discusses the impact assessment results to complement Table 3 and Figs. 5–8.

#### 3.2. Normalization of CML-IA impact categories

To gain insight into the significance of the LCIA results compared to a selected reference, normalization was performed on the 2012 base

**Table 3**

The impact assessment results for the production of 1 kWh of electricity and 1 kWh of heat from Hellisheidi geothermal CHP plant for the categories included in the CML-IA and CED methods.

Impact category	Abbreviation	Unit	1 kWh electricity		1 kWh heat	
			2012 LCI	2017 LCI	2012 LCI	2017 LCI
CML-IA impact categories						
Abiotic depletion	ADP	g Sb eq	$1.8 \times 10^{-5}$	$1.8 \times 10^{-5}$	$1.5 \times 10^{-5}$	$1.5 \times 10^{-5}$
Abiotic depletion (fossil fuels)	ADP <sub>fossil</sub>	kJ	21.6	19.7	18.9	16.9
Global warming	GWP100	g CO <sub>2</sub> eq	15.9	11.4	15.8	11.2
Ozone layer depletion	ODP	g CFC-11 eq	$2.0 \times 10^{-7}$	$1.8 \times 10^{-7}$	$1.6 \times 10^{-7}$	$1.4 \times 10^{-7}$
Human toxicity	HTP	g 1,4-DB eq	5.8	5.0	5.5	4.8
Fresh water aquatic ecotox.	FAETP	g 1,4-DB eq	1.8	1.8	1.7	1.7
Marine aquatic ecotoxicity	MAETP	g 1,4-DB eq	4557.9	4547.4	3827.0	3816.3
Terrestrial ecotoxicity	TETP	g 1,4-DB eq	$2.1 \times 10^{-2}$	$2.1 \times 10^{-2}$	$2.1 \times 10^{-2}$	$2.1 \times 10^{-2}$
Photochemical oxidation	POCP	g C <sub>2</sub> H <sub>4</sub> eq	$9.5 \times 10^{-4}$	$9.1 \times 10^{-4}$	$8.1 \times 10^{-4}$	$7.6 \times 10^{-4}$
Acidification	AP	g SO <sub>2</sub> eq	9.7	3.6	9.7	3.5
Eutrophication	EP	g PO <sub>4</sub> -eq	$5.1 \times 10^{-3}$	$4.8 \times 10^{-3}$	$4.5 \times 10^{-3}$	$4.2 \times 10^{-3}$
Cumulative Energy Demand (CED) impact categories						
Non-renewable, fossil	CED <sub>NR,fossil</sub>	kWh	$6.4 \times 10^{-3}$	$5.8 \times 10^{-3}$	$5.6 \times 10^{-3}$	$5.0 \times 10^{-3}$
Non-renewable, nuclear	CED <sub>NR,nuclear</sub>	kWh	$3.9 \times 10^{-4}$	$3.8 \times 10^{-4}$	$3.1 \times 10^{-4}$	$3.1 \times 10^{-4}$
Non-renewable, biomass	CED <sub>NR,bio</sub>	kWh	$3.7 \times 10^{-6}$	$3.7 \times 10^{-6}$	$2.0 \times 10^{-6}$	$2.0 \times 10^{-6}$
Renewable, biomass	CED <sub>R,bio</sub>	kWh	$1.1 \times 10^{-4}$	$1.1 \times 10^{-4}$	$8.1 \times 10^{-5}$	$8.0 \times 10^{-5}$
Renewable, wind, solar, geothermal	CED <sub>R,s,w,g</sub>	kWh	5.2	5.2	5.2	5.2
Renewable, water	CED <sub>R,water</sub>	kWh	$3.1 \times 10^{-4}$	$3.1 \times 10^{-4}$	$2.8 \times 10^{-4}$	$2.8 \times 10^{-4}$
Total, non-renewable*	CED <sub>NR</sub>	kWh	$6.8 \times 10^{-3}$	$6.2 \times 10^{-3}$	$5.9 \times 10^{-3}$	$5.3 \times 10^{-3}$
Total, renewable*	CED <sub>R</sub>	kWh	5.2	5.2	5.2	5.2
Total	CED <sub>total</sub>	kWh	5.2	5.2	5.2	5.2

\* The total non-renewable and renewable CED results are not given in the CED method but calculated for the sake of informative value in this study.

case results, using the EU25 + 3 reference given in the CML-IA method. Normalization is not a part of the CED method and thus, results for CED are excluded from this section.

EU25 + 3 refers to the annual environmental load of human activities for the reference year 2000 in the 25 member states of the European Union (as of 2006) in addition to Iceland, Norway and Switzerland. The normalization results for electricity and heat are seen in Fig. 9. The results for both products show that the most significant environmental impact compared to the EU25 + 3 is the acidification potential, followed by marine aquatic ecotoxicity. Acidification potential of both heat and electricity is due to emissions of H<sub>2</sub>S from the geothermal power plant while the ecotoxicity potential is mostly due to the production processes for steel, aluminium and copper used in the CHP plant.

### 3.3. Comparison of results with other studies

It is of interest to compare the results for Hellisheidi to the above-mentioned literature. Here, more focus is put on the results for electricity production due to the lack of compatible LCA studies on high-temperature heat production. Also, due to the variability of which impact assessment method is chosen in different LCA studies, it is unfortunately not so straight forward to compare results between studies for all impact categories. The most widely reported impact category in LCA studies is the Global Warming Potential (GWP) representing the overall GHG emissions. The report by Eberle et al. (2017) systematically reviews both published life cycle GHG emissions from LCA studies as well as reported direct emissions from different geothermal technologies. Furthermore, they compile results specifically for high-temperature flash geothermal

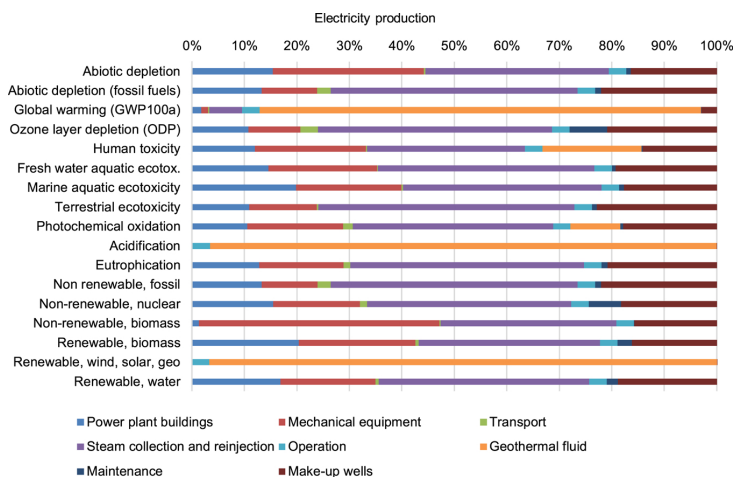

**Fig. 5.** Contribution of the main unit processes for the production of 1 kWh h of electricity at Hellisheidi geothermal CHP plant to the environmental impacts – 2012 data.



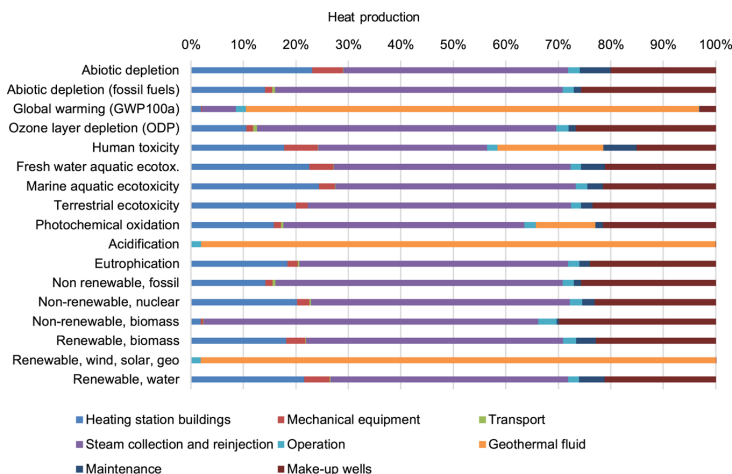

Fig. 6. Contribution of the main unit processes for the production of 1 kWh of heat at Hellisheidi geothermal CHP plant to the environmental impacts – 2012 data.

plants in their review. The study by Buonocore et al. (2015), also included in the report by Eberle et al. (2017), additionally reports various impact category results for a high-temperature dry steam plant in Italy that can be compared to the results from Hellisheidi due to the similar technology and energy conversion cycle used in dry-steam and flash plants. The comparison is shown in Table 4.

Compared to the study by Buonocore et al. (2015), Hellisheidi results are lower in all cases except for the acidification potential (AP). The release of hydrogen sulfide (H<sub>2</sub>S) is responsible for the majority of the AP from the Italian power plant according to Buonocore et al. (2015), which is also the case for Hellisheidi. The difference between the two is likely due to higher H<sub>2</sub>S concentration in the geothermal fluid from the Hellisheidi geothermal field, even in the case where H<sub>2</sub>S abatement (SulFix method) at Hellisheidi in the 2017 LCI results in over 60% reduction of AP results compared to having no mitigation method present for H<sub>2</sub>S abatement in the 2012 LCI.

For the results of GWP in the report by Eberle et al. (2017), including the results from Buonocore et al. (2015), the Hellisheidi results fall into the lower part of the range for the life cycle GHG emission and is much lower than the minimum of the reported direct emissions according to the review report. On contrary to the relatively high H<sub>2</sub>S content of the geothermal fluid at Hellisheidi, the CO<sub>2</sub> content is quite

low and that likely explains the difference in the GWP results between the studies. Also, the mitigation method used to reinject and mineralize a part of the CO<sub>2</sub> with the CarbFix method included in the 2017 LCI results in even lower GWP of Hellisheidi compared to other studies.

Buonocore et al. (2015) report that high levels of arsenic and mercury in the geothermal fluid at the Italian plant have a significant contribution to the human toxicity potential (HT). Due to full reinjection of geothermal fluid at Hellisheidi, resulting in near zero release of geothermal fluid to soil or water from the plant, no such contribution to HT is to be found in the Hellisheidi results. Also, the concentration of arsenic and mercury in the geothermal fluid at Hellisheidi is relatively low. For Hellisheidi, the emission of H<sub>2</sub>S contribute slightly to the HT as discussed in Section 3.1. above, but the overall contribution is due to other unit processes within the construction and maintenance life cycle phases of the plant. Therefore, the presence of emissions of mercury and arsenic in the Italian study is likely to explain the majority of the difference in HT results between the two studies.

Not many geothermal LCA studies give results for the cumulative energy demand (CED) and therefore, the comparison of the Hellisheidi study to the study by Buonocore et al. (2015) is of great value. The results for the CED in both studies are similar in magnitude and the renewable part of the CED dominates the overall result in both studies

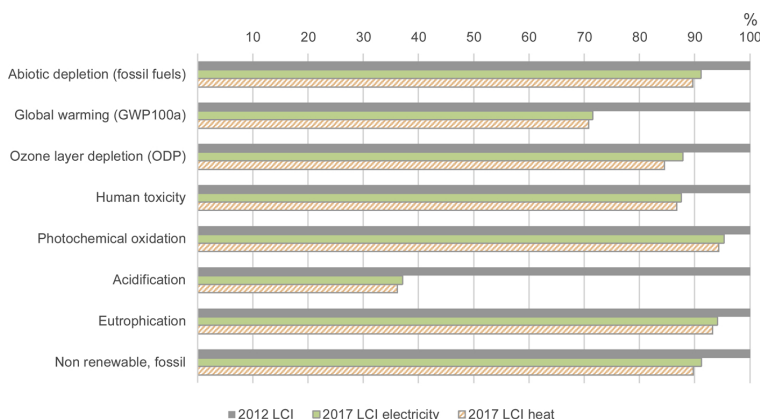
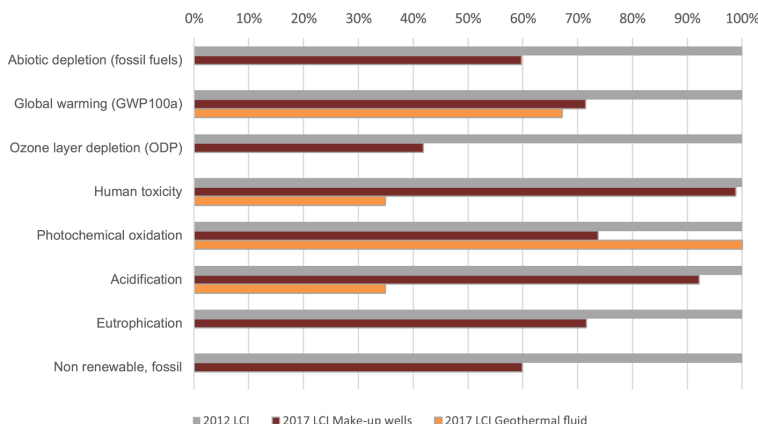

Fig. 7. The relative changes of LCIA results for 1 kWh of electricity and heat compared to the 2012 LCI after considering changes in operations at Hellisheidi geothermal CHP plant (2017 LCI).



**Fig. 8.** The relative reduction of process contribution between 2012 and 2017 LCIs of the two processes that were affected by the updated 2017 LCI; namely the drilling of make-up wells and direct emissions from the use of geothermal fluid for the production at Hellisheidi. The relative reduction was the same for both electricity and heat.

due to the input of geothermal energy during the operation phase of the plants. The Hellisheidi study however shows lower values (meaning a lower need for primary energy input to produce each kWh of electricity and heat) indicating a higher energy efficiency of the Hellisheidi plant compared to the Italian plant. This is to be expected since the Hellisheidi plant is designed with energy efficiency in mind, utilizing a double-flash technology to maximize electricity production and a combined heat production to further utilize the heat from the geothermal fluid for usable energy production. The difference in the non-renewable part of the CED between the studies is difficult to analyze in depth but they both originate mainly from the construction phase of the plants, such as from energy used from production of materials and serve only a small fraction of the overall CED results.

For added perspective, the LCIA results for the 2017 data set, representing today's performance of the plant, is compared to available LCIs in the ecoinvent database for other common energy resources used for the production of electricity or heat. A comparison for electricity production is shown in Fig. 10, where electricity from Hellisheidi is compared to an average hydropower plant in Norway and an average Scandinavian gas power plant, both retrieved from the ecoinvent v3.4 database. The comparison shows that electricity from Hellisheidi has the lowest environmental impacts for most categories except for GWP100 and MAETP where hydropower scores slightly lower, as well

as for AP where geothermal shows significantly higher results per kWh than other processes due to the considerable amount of emissions of H<sub>2</sub>S. Elsewhere, the gas fired power plant has much higher impacts in almost all LCIA categories investigated by the CML-IA baseline method as would be expected in a comparison between gas fueled power plants and renewable technologies.

For comparison of different heat production processes, as shown in Fig. 11, the results are much in favor of the geothermal CHP process. A comparison is made between heat from Hellisheidi and the production of heat from a geothermal heat pump as well as from an average mix of district heating technologies in Europe. The only impact category where geothermal scores higher than the other production processes is, as for the electricity, the acidification potential (AP) due to H<sub>2</sub>S emissions.

#### 4. Conclusions

Using LCA to evaluate the environmental impacts of the joint production of electricity and heat at Hellisheidi geothermal CHP plant reveals some interesting findings. Firstly, most of the impact categories evaluated by the CML-IA baseline method are strongly affected by the construction phase of the power plant due to the use of materials and energy for different components. However, the environmental impacts of utilizing the high-temperature geothermal resource available at

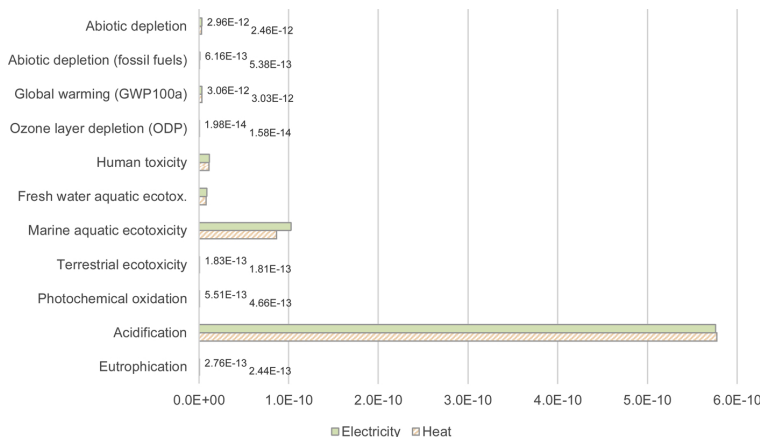

**Fig. 9.** Normalization results for electricity and heat from Hellisheidi geothermal CHP plant compared to the annual environmental load from the year 2000 of the EU25 + 3 states.

The results show that the acidification potential of the two products is the most significant compared with EU25 + 3 environmental impacts.

**Table 4**  
Comparison of selected environmental impact results for high-temperature flash geothermal power plants in literature study to the results for Hellisheiði.

Impact category	Unit	Hellisheiði 2012 LCI	Hellisheiði 2017 LCI	Buonocore et al. (2015)	Eberle et al. (2017) Direct emissions, [min, median, max]	Eberle et al. (2017) Life cycle emissions, [min, median, max]
GWP100	g CO <sub>2</sub> eq	15.9	11.4	248	[110, 151, 690]	[9.7, 73.2, 240.2]
AP	g SO <sub>2</sub> eq	9.7	3.6	3.4	–	–
HT	g 1,4-DB eq	5.8	5.0	11	–	–
CED <sub>R</sub>	kWh	5.2	5.2	6.9*	–	–
CED <sub>NR</sub>	kWh	0.0059	0.0053	0.2*	–	–

\* CED values are retrieved from Buonocore et al. (2015) in [MJ CED/kWh functional unit] and adapted to the corresponding unit of [kWh CED/kWh functional unit] for the purpose of comparison.

Hellisheiði are strongly evident in the LCIA results as the emissions of various geothermal gasses, mainly CO<sub>2</sub> and H<sub>2</sub>S, contribute substantially to GWP100, HT and AP. These impacts can vary greatly between different geothermal sites since the natural characteristics of geothermal fluids are very site specific. Thus, the results for Hellisheiði cannot be generalized for other geothermal power plants without adjusting for the variations in chemical content, such as the amount of various geothermal gasses, of different geothermal fluids.

Some significant improvements have already been made on the operation of Hellisheiði CHP plant since it was commissioned in 2006 by adopting mitigation methods for reducing geothermal gas emissions and by replacing use of fossil fuels during the otherwise fuel intensive process of drilling new wells with the power plant’s own generated electricity. These improvements have led to significant positive changes in the overall environmental performance of the plant. Further improvements could be made by increasing the reinjection of geothermal gasses even more or using other mitigation methods to avoid the direct emissions of these gases. Otherwise, the effects of the constructional phase of the CHP plant, that accounts for a large amount of various impact categories, cannot be changed afterwards. Instead, the choice of materials for future geothermal projects could be re-evaluated to further improve the environmental performance of those future plants if possible. However, an increased lifetime of the plant beyond the modelled 30-year operational lifetime would reduce these impacts per functional unit, increasing the environmental performance of the plant.

The choice of allocation method becomes an evident dilemma in the assessment of the Hellisheiði plant. This study assumed that the two

products are both equally vital outputs from the energy conversion system and thus, the joint input processes were divided between the two products based on their share in the overall useful energy production of the plant. In that way, the environmental impacts of joint processes per functional unit are equal. This assumption can certainly be debated, and other allocation methods could be used with equally valid arguments of for example the difference in economic value of these two products. The authors will further present the effects of the choice of different allocation methods on LCIA results for electricity and heat from the Hellisheiði CHP plant in a separate study.

The main limitations of the study are twofold; (1) The generality of the results is low due to the site-specific operational variables of geothermal utilization as discussed earlier. The findings of this study suggest that the impact categories most sensitive to the amount of direct emissions of geothermal gasses such as CO<sub>2</sub>, CH<sub>4</sub> and H<sub>2</sub>S, which are always very site specific for each geothermal power plant in question, are *global warming potential* (GWP100), *acidification potential* (AP), *human toxicity* (HTP) and *photochemical oxidation potential* (POCP). As an example, the Hellisheiði CHP plant has amongst the lowest emission of CO<sub>2</sub> per kWh from geothermal power plants worldwide as reported in the study by Bertani and Thain (2002) due to the low concentration of CO<sub>2</sub> in the geothermal steam on site. Therefore, other geothermal plants might report substantially higher emissions of CO<sub>2</sub> than in this study. However, the Hellisheiði plant has considerably higher emission of H<sub>2</sub>S per kWh than other geothermal power plants in Iceland leading to potentially higher environmental impacts in categories affected by H<sub>2</sub>S than for other plants. (2) The results are also sensitive to the choice

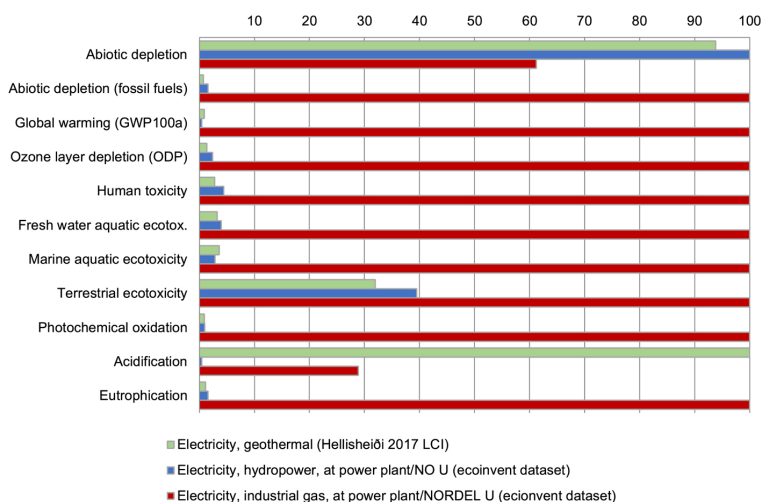

**Fig. 10.** Comparison of LCIA results for electricity production from Hellisheiði geothermal CHP plant (2017 data set), an average hydropower plant located in Norway and an average gas power plant in Scandinavia. Datasets retrieved from the ecoinvent v3.4 database (Treyer and Bauer, 2013).

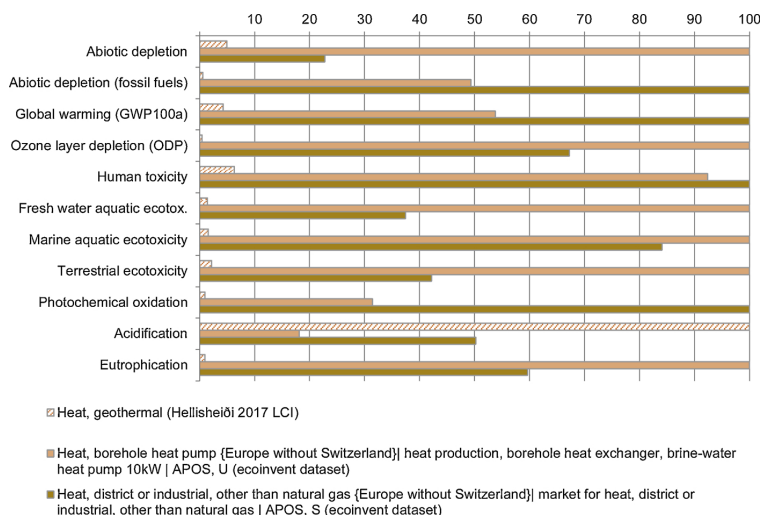

Fig. 11. Comparison of LCIA results for heat production from Hellisheiði geothermal CHP plant (2017 data set), an average geothermal heat pump in Europe and an average district heating system in Europe. Data is retrieved from the ecoinvent v3.4 database (ecoinvent Centre, 2013).

of input data from databases (secondary data), such as for different material production processes from the ecoinvent v3.4 database, since a large share of the impacts are derived from these background processes. For this study, wherever possible, average datasets or European datasets were used to compile the LCI because actual locations for different material production facilities were not known.

The LCIA results reflect well upon many of the recognized environmental issues of geothermal utilization in Iceland. One such issue is the effect of  $H_2S$  emissions on the environment and human health. The concentration of  $H_2S$  in the vicinity of Hellisheiði geothermal CHP plant was publicly debated by the local communities due to odor nuisance after the plant started operation in 2006 and due to unknown health effects of  $H_2S$  in continuous and low concentration. As a result, new regulation on lower allowable  $H_2S$  levels was implemented and mitigation measures needed to be installed at the plant to comply with the new regulation. Also, the high acidification potential results due to  $H_2S$  emissions reflect well upon a local discussion whether the gas is responsible for increased corrosion of metals that are subjected to higher levels of  $H_2S$  in close vicinity of the plant. However, for all other impact categories than AP, the comparison of geothermal utilization for heat and power production with other conventional energy generation technologies shows that geothermal utilization is a preferable option in almost all aspects. Furthermore, the environmental issues connected with geothermal utilization at Hellisheiði have been largely avoided by mitigation methods, resulting in a very high environmental performance of the plant compared to others.

Some impacts of the Hellisheiði geothermal CHP plant are however not addressed in the LCIA. An example is the effect of reinjection of geothermal fluid on induced seismicity in the area (Juncu et al., 2018). Another example is the potential thermal effects of surface release of hot geothermal fluid on local surroundings. Third example is potential loss of biological diversity due to habitat destruction or effects of release of geothermal fluid or gasses (e.g. Mutia et al. (2016)). These impacts are well known and are commonly addressed in environmental impact assessments (EIA) prior to the construction of geothermal projects in Iceland. Mitigation methods are also available for minimizing those impacts.

In conclusion, geothermal utilization of high-temperature resources can potentially have low environmental impacts compared to most other energy sources. Sustainable utilization of geothermal resources using advanced technological solutions to minimize their main

environmental impacts should make geothermal utilization one of the future solutions in meeting the world's energy demand wherever geological conditions allow.

#### Data availability

This work is based on a previously published dataset by Karlsdóttir et al. (2015) and the results can be fully reproduced by the use of the published dataset along with additional information given in this manuscript.

#### Declaration of Competing Interest

The authors declare that they have no known competing financial interests or personal relationships that could have appeared to influence the work reported in this paper.

#### Acknowledgements

This work is a part of the Primary Energy Efficiency (PEE) project that was funded by Nordic Energy Research and co-financed by National Energy Fund (Orkusjóður) owned by the Government of Iceland and the Landsvirkjun Energy Research fund. Reykjavik Energy, and its subsidiary ON Power, supported the work by providing data on the Hellisheiði geothermal CHP plant along with expert advice. Special thanks to Einar Gunnlaugsson and other specialists at Reykjavik Energy.

#### Appendix A. Supplementary data

Supplementary material related to this article can be found, in the online version, at doi:<https://doi.org/10.1016/j.geothermics.2019.101727>.

#### References

- 2nd Master Plan Steering Committee, 2011. Results of the 2nd Master Plan (in Icelandic). Aradóttir, E.S.P., Gunnarsson, I., Sigfússon, B., Gunnarsson, G., Júlíusson, B.M., Gunnlaugsson, E., Sigurdardóttir, H., Amarnson, M.T., Sonnenthal, E., 2015. Toward cleaner geothermal energy utilization: capturing and sequestering CO<sub>2</sub> and H<sub>2</sub>S emissions from geothermal power plants. *Transp. Porous Media* 108, 61–84.
- Bayer, P., Rybach, L., Blum, P., Brauchler, R., 2013. Review on life cycle environmental effects of geothermal power generation. *Renew. Sustain. Energy Rev.* 26, 446–463.

- Bertani, R., Thain, I., 2002. Geothermal Power Generating Plant CO<sub>2</sub> Emission Survey. IGA news, pp. 1–3.
- Buonocore, E., Vanoli, L., Carotenuto, A., Ulgiati, S., 2015. Integrating life cycle assessment and energy synthesis for the evaluation of a dry steam geothermal power plant in Italy. *Energy* 86, 476–487.
- Burchart-Korol, D., Korol, J., Czaplicka-Kolarz, K., 2016. Life cycle assessment of heat production from underground coal gasification. *Int. J. Life Cycle Assess.* 21, 1391–1403.
- Eberle, A., Heath, G.A., Carpenter Petri, A.C., Nicholson, S.R., 2017. Systematic Review of Life Cycle Greenhouse Gas Emissions From Geothermal Electricity, United States. Ecoinvent Centre, 2013. Ecoinvent Version 3.
- Frick, S., Kaltschmitt, M., Schroder, G., 2010. Life cycle assessment of geothermal binary power plants using enhanced low-temperature reservoirs. *Energy* 35, 2281–2294.
- Goldstein, B., Hiriart, G., Bertani, R., Bromley, C., Gutiérrez-Negrín, L., Huenges, E., Muraoka, H., Ragnarsson, A., Tester, J., Zui, V., 2011. Geothermal energy. In: Edenhofer, O., Pichs-Madruga, R., Sokona, Y., Seyboth, K., Matschoss, P., Kadner, S., Zwickel, T., Eickemeier, P., Hansen, G., Schlömer, S., von Stechow, C. (Eds.), IPCC Special Report on Renewable Energy Sources and Climate Change Mitigation. Cambridge University Press, Cambridge, United Kingdom and New York, NY, USA.
- Guinée, J.B.G., Heijungs, M., Huppes, R., Kleijn, G., Koning, R., de Oers, A., van Wegene Sleswijk, L., Suh, A., Udo de Haes, S., Bruijn, H.A., de Duijn, H., van, R., Huijbregts, M.A.J., 2002. Handbook on Life Cycle Assessment. Operational Guide to the ISO Standards. I: LCA in Perspective. Ila: Guide. Iib: Operational Annex. III: Scientific Background. Kluwer Academic Publishers, Dordrecht.
- Gunnarsson, G., Mortensen, A.K., 2016. Dealing with intense production density: challenges in understanding and operating the Hellisheiði geothermal field, SW-Iceland. In: Proceedings, 41st Workshop on Geothermal Reservoir Engineering, Stanford University, Stanford, California.
- Gunnarsson, I., Aradóttir, E.S., Oelkers, E.H., Clark, D.E., Arnarson, M.P., Sigfússon, B., Snæbjörnsdóttir, S.Ó., Matter, J.M., Stute, M., Júlíusson, B.M., Gíslason, S.R., 2018. The rapid and cost-effective capture and subsurface mineral storage of carbon and sulfur at the CarbFix2 site. *Int. J. Greenh. Gas Control.* 79, 117–126.
- Hanbury, O., Vasquez, V.R., 2018. Life cycle analysis of geothermal energy for power and transportation: a stochastic approach. *Renew. Energy* 115, 371–381.
- Heinonen, J., Laine, J., Pluuman, K., Säynäjoki, E.-S., Soukka, R., Junnila, S., 2015. Planning for a low carbon future? Comparing heat pumps and cogeneration as the energy system options for a new residential area. *Energies* 8, 9137.
- Hellweg, S., Milà i Canals, L., 2014. Emerging approaches, challenges and opportunities in life cycle assessment. *Science* 344, 1109–1113.
- Hischier, R.W.B., Althaus, H.-J., Bauer, C., Doka, G., Dones, R., Frischknecht, R., Hellweg, S.H.S., Jungbluth, N., Köllner, T., Loerincik, Y., Margni, M., T. N., 2010. Implementation of Life Cycle Impact Assessment Methods. Ecoinvent Report No. 3, v2.2. Dübendorf.
- Hondo, H., 2005. Life cycle GHG emission analysis of power generation systems: Japanese case. *Energy* 30, 2042–2056.
- Hussy, C., Klaassen, E., Koornneef, J., Wigand, F., 2014. International Comparison of Fossil Power Efficiency and CO<sub>2</sub> Intensity - Update 2014. Utrecht, the Netherlands.
- ISO 14040, 2006. Environmental Management - Life Cycle Assessment -Principles and Framework (ISO 14040:2006). ISO - International Organization for Standardization, Switzerland.
- Juncu, D., Árnadóttir, T., Geirsson, H., Guðmundsson, G.B., Lund, B., Gunnarsson, G., Hooper, A., Hreinsdóttir, S., Michalczyewska, K., 2018. Injection-induced surface deformation and seismicity at the Hellisheiði geothermal field, Iceland. *J. Volcanol. Geotherm. Res.*
- Júlíusson, E., Axelsson, G., 2018. Stock models for geothermal resources. *Geothermics* 72, 249–257.
- Karlsdóttir, M.R., Palsson, H., Palsson, O.P., 2010. Factors for primary energy efficiency and CO<sub>2</sub> emission of geothermal power production. In: World Geothermal Congress 2010. Bali, Indonesia.
- Karlsdóttir, M.R., Palsson, H., Palsson, O.P., Maya-Drysdale, L., 2015. Life cycle inventory of a flash geothermal combined heat and power plant located in Iceland. *Int. J. Life Cycle Assess.* 1–17.
- Karlsson, J., Brunzell, L., Venkatesh, G., 2018. Material-flow analysis, energy analysis, and partial environmental-LCA of a district-heating combined heat and power plant in Sweden. *Energy* 144, 31–40.
- Marchand, M., Blanc, I., Marquand, A., Beylot, A., Bezalgues-Courtade, S., Traineau, H., 2015. Life cycle assessment of high temperature geothermal energy systems. In: World Geothermal Congress 2015. Melbourne, Australia.
- Martinez-Corona, J.I., Gibon, T., Hertwich, E.G., Parra-Saldivar, R., 2017. Hybrid life cycle assessment of a geothermal plant: from physical to monetary inventory accounting. *J. Clean. Prod.* 142, 2509–2523.
- Matter, J.M., Stute, M., Snæbjörnsdóttir, S.Ó., Oelkers, E.H., Gíslason, S.R., Aradóttir, E.S., Sigfússon, B., Gunnarsson, I., Sigurdardóttir, H., Gunnlaugsson, E., Axelsson, G., Alfreðsson, H.A., Wolff-Boenisch, D., Mesfin, K., Taya, D.Fdl.R., Hall, J., Dideriksen, K., Broecker, W.S., 2016. Rapid carbon mineralization for permanent disposal of anthropogenic carbon dioxide emissions. *Science* 352, 1312–1314.
- Menberg, K., Pfister, S., Blum, P., Bayer, P., 2016. A matter of meters: state of the art in the life cycle assessment of enhanced geothermal systems. *Energy Environ. Sci.* 9, 2720–2743.
- Moomaw, W., Burgherr, P., Heath, G., Lenzen, M., Nyboer, J., Verbruggen, A., 2011. Annex II: Methodology. In IPCC Special Report on Renewable Energy Sources and Climate Change Mitigation. Cambridge, United Kingdom and New York, NY, USA.
- Mutia, T.M., Fridriksson, T., Jónsdóttir, I.S., 2016. Concentrations of sulphur and trace elements in semi-arid soils and plants in relation to geothermal power plants at Olkaria, Kenya. *Geothermics* 61, 149–159.
- National Energy Authority, 2017a. Energy Statistics in Iceland 2016. Orkustofnun National Energy Authority, Reykjavík.
- National Energy Authority, 2017b. Primary Energy Use in Iceland 1940–2016. Reykjavík.
- ON Power, 2017. Press Release.
- PRÉ, 2018. Sima Pro Database Manual, Methods Library, 4.1 ed.
- Ristimäki, M., Säynäjoki, A., Heinonen, J., Junnila, S., 2013. Combining life cycle costing and life cycle assessment for an analysis of a new residential district energy system design. *Energy* 63, 168–179.
- Rule, B.M., Worth, Z.J., Boyle, C.A., 2009. Comparison of life cycle carbon dioxide emissions and embodied energy in four renewable electricity generation technologies in New Zealand. *Environ. Sci. Technol.* 43, 6406–6413.
- Sigfússon, B., Arnarson, M.P., Snæbjörnsdóttir, S.Ó., Karlsdóttir, M.R., Aradóttir, E.S., Gunnarsson, I., 2018. Reducing emissions of carbon dioxide and hydrogen sulphide at Hellisheiði power plant in 2014–2017 and the role of CarbFix in achieving the 2040 Iceland climate goals. *Energy Procedia* 146, 135–145.
- Skone, T.J., Littlefield, J., Eckard, R., Cooney, G., Marriott, J., 2012. Role of Alternative Energy Sources: Geothermal Technology Assessment U.S. National Energy Technology Laboratory.
- Sullivan, J.L., Stephens, T., Wang, M., 2014. Geothermal Power Production: Alternative Scenarios and Critical Issues. Argonne National Lab. (ANL), United States.
- Sullivan, J.L., Wang, M.Q., 2013. Life cycle greenhouse gas emissions from geothermal electricity production. *J. Renew. Sustain. Energy* 5.
- The International EPD System, 2015. Product Category Rules According to ISO 14025, 3 ed.
- The Master Plan for Nature Protection and Energy Utilization, 2017. The Master Plan Today.
- Tomasini-Montenegro, C., Santoyo-Castelazo, E., Gujba, H., Romero, R.J., Santoyo, E., 2017. Life cycle assessment of geothermal power generation technologies: an updated review. *Appl. Therm. Eng.* 114, 1119–1136.
- Treyer, K., Bauer, C., 2013. Life cycle inventories of electricity generation and power supply in version 3 of the ecoinvent database—part I: electricity generation. *Int. J. Life Cycle Assess.* 1–19.
- Varun Bhat, I.K., Prakash, R., 2009. LCA of renewable energy for electricity generation systems—a review. *Renew. Sustain. Energy Rev.* 13, 1067–1073.
- VGK consulting, 2005. EIA for Hellisheiði CHP plant (in Icelandic: Staðkunn Hellisheiðarvirkjunar. Mat á umhverfisáhrifum). Reykjavík.



# Paper III

Karlsdottir, M. R., Heinonen, J., Palsson, H., & Palsson, O. P. (2020). High-Temperature Geothermal Utilization in the Context of European Energy Policy - Implications and Limitations. *Energies*, 13(12), 3187.





Article

# High-Temperature Geothermal Utilization in the Context of European Energy Policy—Implications and Limitations

Marta Ros Karlsdottir <sup>1,\*</sup>, Jukka Heinonen <sup>2</sup>, Halldor Pálsson <sup>1</sup> and Olafur Petur Pálsson <sup>1</sup>

<sup>1</sup> Faculty of Industrial Engineering, Mechanical Engineering and Computer Science, University of Iceland, VR-II, Hjardarhaga 6, 107 Reykjavik, Iceland; halldorp@hi.is (H.P.); opp@hi.is (O.P.P.)

<sup>2</sup> Faculty of Civil and Environmental Engineering, University of Iceland, VR-II, Hjardarhaga 6, 107 Reykjavik, Iceland; heinonen@hi.is

\* Correspondence: mrk1@hi.is

Received: 1 May 2020; Accepted: 13 June 2020; Published: 19 June 2020



**Abstract:** The European Union (EU) has made climate change mitigation a high priority through a policy framework called “Clean Energy for all Europeans”. The concept of primary energy for energy resources plays a critical role in how different energy technologies appear in the context of this policy. This study shows how the calculation methodologies of primary energy content and primary energy factors pose a possible negative implication on the future development of geothermal energy when comparing against EU’s key energy policy targets for 2030. Following the current definitions of primary energy, geothermal utilization becomes the most inefficient resource in terms of primary energy use, thus contradicting key targets of increased energy efficiency in buildings and in the overall energy use of member states. We use a case study of Hellisheidi, an existing geothermal power plant in Iceland, to demonstrate how the standard primary energy factor for geothermal in EU energy policy is highly overestimated for efficient geothermal power plants. Moreover, we combine life cycle assessment and the commonly utilized combined heat and power production allocation methods to extract the non-renewable primary energy factor for geothermal and show how it is only a minimal fraction of the total primary energy factor for geothermal. The findings of the study apply to other geothermal plants within the coverage of the European Union’s energy policy, whether from high- or low-temperature geothermal resources. Geothermal has substantial potential to aid in achieving the key energy and climate targets. Still, with the current definition of the primary energy of geothermal resources, it may not reach the potential.

**Keywords:** geothermal; European Union (EU); energy policy; primary energy; greenhouse gas (GHG) emissions; life cycle assessment (LCA); combined heat and power (CHP); allocation

## 1. Introduction

The European Union (EU) has put forward an ambitious energy and climate policy framework called “Clean Energy for all Europeans”. The policy framework defines specific targets to be met by the year 2030 to reduce greenhouse gas (GHG) emissions, increase the share of renewable energy in the EU’s energy mix and increase energy efficiency throughout the entire energy value chain [1]. Essential indicators to track the progress towards the EU’s climate and energy targets are GHG emission factors for different energy technologies and the primary energy factor (PEF). The PEF states how efficient energy technologies are in converting primary energy from various resources into usable energy products such as electricity and heat.

GHG emission factors are readily available in literature and industry standards for the different energy technologies, based on data from multiple sources. The PEFs, however, are more complicated to

define, as the physical properties of different fuels and energy resources may vary significantly, resulting in a complexity of defining their actual primary energy content. In international energy statistics, methods have been set on how to calculate the primary energy content of the different fuels and energy resources [2,3], and the EU energy and climate policy framework adheres to those methods [3]. However, the methods have had some criticism from various stakeholders within the energy industry. The methods do not apply a consistent methodology to define the primary energy content across different resources. In return, they become difficult to compare between various resources and even produce unfavorable indicators and statistical results for renewable energy resources [4–7].

One particular energy technology that can be negatively affecting the EU's climate and energy targets due to the definition of the PEF is geothermal energy. Geothermal energy is utilized worldwide as a reliable renewable and low-emitting source of heat and power, providing continuous base-load energy production in contrast to the highly fluctuating production profiles of, e.g., wind and solar energy. Furthermore, geothermal energy is an excellent source of heat for district heating purposes. Geothermal energy technologies typically have lower conversion efficiencies compared to other thermal energy technologies due to the naturally available temperatures and pressures from the individual geothermal resources. These low efficiencies result in higher PEFs for geothermal than for other technologies, which can negatively affect energy efficiency targets based on primary energy measures in countries developing future geothermal projects.

This paper discusses the possible implications and limitations on current and future development of geothermal energy due to how the PEF for geothermal is defined within the EU's climate and energy policy. In particular, it focuses on high-temperature geothermal utilization and gives an actual technical example to support the discussion. Also, the paper addresses the methods used to allocate the PEF and GHG emission factor between electricity and heat from combined heat and power (CHP) plants, with a focus on how they apply to high-temperature geothermal CHP plants, and how they affect the outcome of an assessment. The study uses a technical example derived from a previously published paper by the authors on the life cycle assessment (LCA) of the largest geothermal power plant in Iceland, the Hellisheidi geothermal CHP plant [8].

The following subsections of Section 1 provide the context for the paper. They cover the ongoing discussion on the newly updated EU climate and energy policy framework and the key indicators used within the framework to address the climate and energy targets. Furthermore, they discuss the status of geothermal energy in Europe and how the current policy framework can have potential adverse effects on the further development of geothermal utilization within the EU.

Section 2 covers the methods chosen to showcase the implications of the EU policy framework on geothermal development by introducing a technical example of an existing high-temperature geothermal CHP plant located in Iceland. The methods for calculating the PEFs for the plant are described and discussed. Additionally, the methods used to calculate allocation factors based on different methodologies, including EU's preferred methods of allocation, to divide the PEF and other environmental impacts between power and heat for the technical example are given. Section 3 presents the results of the allocation factors and their impact on the values of PEF for electricity and heat from the geothermal CHP plant. A discussion of the results and concluding remarks are given in Sections 4 and 5, respectively.

The paper will show that the definition of PEF for geothermal energy, or the use of primary energy as a target measure, should be reconsidered if geothermal energy is to become one of the renewable energies the EU relies on for clean energy in the future. The current definitions and targets can undermine the development of geothermal energy within the EU as replacing any energy technology with geothermal technology, either in a building or in a Member State, results in increased primary energy use due to the high PEF value of geothermal. The authors believe that this was not the intended purpose of the current climate and energy policy nor international energy statistics methods, and should, therefore, be revised to support future geothermal development.

### 1.1. Overview of Current EU Energy and Climate Policy

The European Union (EU) has shown a noticeable ambition to put forward clear and forward-thinking climate and energy goals and supporting legislative acts. The EU first adopted a package of energy and climate measures in 2008, setting the 20/20/20 targets. These targets aimed at decreasing GHG emissions by 20% (from 1990 levels), increase energy efficiency by 20% (compared to “business as usual” scenario projections for 2020 energy use made in 2007), and to achieve a 20% share of renewables within the EU. Already in 2012, reports showed the EU was well on its way of meeting the 20/20/20 targets. As of 2017, according to Eurostat [9], the 20% reduction in GHG emissions from 1990 levels was already met and surpassed, while the share of renewables measured 17.5% and energy efficiency for final- and primary energy consumption lacked 3.3% and 5% points towards its goal respectively. The next update on the progress towards the 2020 targets is expected from Eurostat in fall 2020.

The European Commission, therefore, requested the construction of the next climate and energy framework to set ambitious key targets for the period 2021–2030 [10]. In 2015, the new 2030 climate and energy framework, “Clean energy for all Europeans”, was adopted with updated targets from the 2020 package. Furthermore, the targets for energy efficiency and share of renewables were revised upwards in 2018. The following key targets are now adopted [1,11,12]:

- No less than a 40% reduction of greenhouse gas emissions compared to 1990 levels. The target is twofold, where sectors under the EU emissions trading system (ETS) must cut emissions by 43%, and non-ETS sectors (emissions under each Member State) need to reduce emissions by 30%, both compared to 2005 levels [11].
- No less than a 32% share of renewable energy in final energy use (revised upwards in 2018 from a target of 27%) [1,11].
- No less than a 32.5% improvement in energy efficiency compared to projections from 2007 (revised upwards in 2018 from a target of 27%) [1,11].

The “Clean energy for all Europeans package” is reinforced by revising and grouping eight legislative acts to support those key targets. An overview of those legal acts is given in Table 1 [1].

**Table 1.** Overview of the eight legislative acts combined in the Clean Energy for all Europeans package (adopted from [1]).

Legislative Act	Official Journal Publication (Date and Official Document)
Energy Performance in Buildings Directive (EPBD)	19/06/2018 - Directive 2018/844
Renewable Energy Directive (RED)	21/12/2018 - Directive 2018/2001
Energy Efficiency Directive (EED)	21/12/2018 - Directive 2018/2002
Governance of the Energy Union	21/12/2018 - Regulation 2018/1999
Electricity Regulation	14/06/2019 - Regulation 2019/943
Electricity Directive (ED)	14/06/2019 - Directive 2019/944
Risk Preparedness	14/06/2019 - Regulation 2019/941
Agency for the Cooperation of Energy Regulators (ACER)	14/06/2019 - Regulation 2019/942

Additionally, as a long term strategy, the EU aims to be “climate-neutral” by 2050 as put forward in “The European Green deal” growth strategy for the EU, presented in December 2019 [13]. A first-of-its-kind European Climate law has been proposed to make the target legally binding [14].

### 1.2. Indicators for Energy Technologies Affecting Key EU Energy and ClimateT

Important indicators for energy technologies within the EU climate and energy policy are the Greenhouse Gas (GHG) Emission Factor and the Primary Energy Factor (PEF). The definitions of how these indicators are calculated for different energy technologies can have a significant effect on how the

technologies compare against the overall progress in reaching the EU's key 2030 energy and climate targets. For instance, one energy technology can have higher GHG emissions compared to others, leading to an increase or slower reduction of GHG emissions overall. Yet, the same energy technology might have a higher conversion efficiency (and thus, a lower primary energy factor) than others leading to lowered primary energy consumption compared to other technologies and therefore contributes more to the increased energy efficiency target and vice versa. The following sections discuss further the state and definition of these indicators for energy technologies.

### 1.2.1. Greenhouse Gas Emission Factors

The greenhouse gas (GHG) emission factor is used as a descriptive indicator of GHG emissions resulting from different energy technologies. The indicator is used as a measure towards the target of reduced GHG emissions, and an optional indicator in the Energy Performance of Buildings Directive (EPBD) to state the energy performance of a building in terms of annual GHG emissions per m<sup>2</sup> [15]. In the Renewable Energy Directive (RED), the indicator is used as a determining factor for the support and development of renewable resources that emit GHG (i.e., by excluding those renewable technologies that might emit a similar amount of GHG as fossil technologies) [16].

The calculation of greenhouse gas emission factors for different energy technologies is a widely studied field, preferably using LCA or other comparable methods to calculate the overall emissions throughout the energy value-chain per energy unit produced or sold [17]. Average emission factors for energy production from different resources are also widely available in literature, as well as case studies on specific energy production facilities worldwide. Therefore, the science of calculating CO<sub>2</sub> emissions from energy production is relatively mature and agreed upon, as well as increasingly comparable between different energy resources and energy conversion technologies.

However, the GHG factors from various studies still vary quite significantly for many energy technologies, and the use of lower or higher end estimates may substantially alter the outcome of an assessment and entirely change the policy-recommendations [18]. In a typical grid, the average and marginal technologies may also be very different. Therefore, the emission factors for marginal and average production can be far apart, and those for marginal can change from one moment to another [19]. Biofuels are a known example where the assessment assumptions and the actual local conditions may significantly affect the assessment outcome [17]. Furthermore, Zhang et al. [20] demonstrate how simply a different leak rate, within typical leak range, may lead to a natural gas plant reaching a higher emissions rate than a coal plant. Farsaei et al. [21] also point out the implications that national energy policies aiming at reduced GHG emissions by closing down the most GHG intensive energy systems, can have significant impacts on wider regions with strongly connected international energy markets. Policies that fail to take these impacts into account may lead to unwanted adverse effects of increased emissions in the region due to increased import of GHG intensive electricity from other markets instead. This implies that a system-wide approach to lowering GHG emissions within the EU should be applied rather than focusing on individual country contributions in an already interlinked energy transmission system across Europe. An additional problematic issue is the combined production of heat and electricity, where the allocation choice can entirely change the split of emissions between the two outputs (e.g., [22]).

### 1.2.2. Primary Energy Factors (PEF) for Different Energy Systems

The concept of primary energy is generally used to define the energy content of the primary energy resource (fossil, hydro, solar, wind, geothermal, etc.) from which usable energy is produced (electricity, heat, fuels for transportation, etc.). It is widely used to describe the physical flow of energy in energy systems, comparison of national energy uses in statistical reports, and recently also as a key indicator of energy systems in energy policy [6]. Primary energy factors (PEF) describe how efficiently a flow of primary energy from an energy resource is converted into usable energy products.

The PEF is a fundamental indicator for calculating the primary energy use, either of a single building or in a broader perspective (e.g., on a regional level) in EU energy policy. The Energy Efficiency Directive (EED) relies on PEFs to account for the savings and annual reduction of primary energy use of Member States towards the target of increased energy efficiency (also closely related to the decrease of greenhouse gas emissions target) within the Union [23]. It is also fundamental for the EPBD to calculate the energy performance of buildings, where it serves as a basis for the mandatory energy performance indicator stating the primary energy use of a building in kWh/m<sup>2</sup>/year [15]. These indicators are then made visible in energy performance certificates of buildings (e.g., [24]).

The definition of primary energy, and consequently, the resulting PEFs for different energy technologies, is not as straightforward as for calculating their GHG emission factors. Due to the significant differences in the physical properties of various energy resources (renewable, non-renewable, thermal resources, combustible resources, kinetic energy, photovoltaic energy, etc.), different definitions may be set for the primary energy content of each resource.

Firstly, the form of the primary energy content of the various energy resources must be defined. Definitions of how to calculate the primary energy content of different resources are given by the statistical office of the EU, Eurostat [3]. They base their definitions of primary energy content on the same basis as the International Energy Agency (IEA) and the International Recommendations for Energy Statistics (IRES) do for their energy balance statistics [2]. They all use the “physical energy content” method, where the general principle is that “the primary energy form is taken as the first flow in the production process that has a practical energy use” [3]. Furthermore, Eurostat defines three different situations of determining the primary energy content depending on the type of energy source:

- For directly combustible energy resources (e.g., lignite, natural gas, gasoline, biogas, firewood, and combustible municipal waste), their primary energy form is defined as the heat generated during combustion [3].
- For energy resources that are not directly combustible, the primary energy form is chosen as:
  - the heat content of the working fluid (the fluid that delivers the primary energy to the conversion cycle) for nuclear, geothermal, solar thermal, and ambient heat, and;
  - the produced electricity output from the energy conversion cycle for solar photovoltaic, wind, hydro, tide, wave and other ocean energy [3].

Secondly, the PEF of different energy systems is the conversion factor between the final usable energy product (i.e., electricity or heat) and the primary energy supplied to the energy production from the resource [25]. Therefore, the PEF states how efficiently the energy system converts primary energy from a resource to a usable energy product. A simplified general equation for calculating the PEF for energy products according to the Eurostat definition is given in Equation (1):

$$\text{PEF}_{\text{energy system}} = \frac{\text{Primary energy input from resource}}{\text{Usable energy output}} = \begin{cases} 1 \\ \frac{1}{\eta} \end{cases} \quad (\text{for most renewables}) \quad (1)$$

where  $\eta$  is the 1st law (thermal) efficiency of the energy conversion process. As can be seen from Equation (1), the PEF for most renewable sources becomes 1 (corresponding to 100% efficiency) due to the definition by the IEA of the primary energy content of most renewable energy resources. For other energy resources, the PEF is a function of the particular energy technology’s thermal efficiency  $\eta$ .

### 1.2.3. Adding Life Cycle Perspectives into the PEF

The new standards for energy performance of buildings (EPB) ISO 52000-1 [25] and CEN ISO 52000-2 [26] (substituting the former ISO 15603:2007 standards on the same subject) further define the calculation methods for PEFs and discuss their application to comply with the EPBD. The EPB standards also encourage the assessment of up-stream primary energy use to extract, supply,

and convert the primary energy into electricity to be included in the overall PEF value. Thus, LCA is an applicable standardized method to calculate PEF for energy systems, as it requires the inclusions of these up-stream processes (e.g., [27–29]). By taking the up-stream processes into account, the PEF increases according to their primary energy demand. Furthermore, the use of an LCA approach for calculating the PEF can reveal otherwise hidden primary energy inputs of energy conversion cycles, linked to their upstream processes. As an example, the use of non-renewable resources becomes evident even in the production of energy products from renewable sources as energy, often of non-renewable origin, to manufacture equipment, materials, and constructing facilities is taken into account in the calculation of the PEF. The same benefits of using LCA applies to the calculation of the GHG emission factor.

#### 1.2.4. Possible Implications of PEFs for Different Energy Systems on EU Climate and Energy Targets

As discussed in the sections above, the various definitions of the primary energy content of energy resources and fuels have a substantial impact on the results for the PEF for different energy technologies. These definitions have had some debate, mainly due to the possible implications and negative side-effects they may have on the comparison of different energy systems and their accountability towards the key energy and climate targets (e.g., [7,30]).

As an example, the share of renewables in a country's reported primary energy mix may seem low if it consists of a mix of non-thermal renewables (e.g., wind, solar-voltaic, hydro) and non-renewable resources. The PEF for the renewables is defined as 1, as opposed to a PEF ranging from 2–4 for the non-renewables. This can lead to an underrepresentation of the share of renewables in the country's energy mix compared to the non-renewables that have more weight in the primary energy mix due to their higher PEFs.

Another example to be mentioned is the use of thermal renewable resources, such as geothermal and solar thermal energy. In the case of these resources, the primary energy is defined as the heat content of the working fluid. The PEFs are calculated from their thermal efficiencies, which are relatively low compared to, e.g., high-efficiency fossil fuel plants. This definition results in a possible overrepresentation of the importance of these resources. Due to their high PEF value of up to 10 for electricity from geothermal resources [3], compared to 1 for other non-thermal renewables, the renewable share of primary energy use in countries relying on those resources becomes exaggerated compared to using other renewable technologies in combination with non-renewable sources.

In the context of buildings, one of the main sectors of PEF utilization through the EPB directive, the use of primary energy instead of delivered energy to assess buildings' energy performance has been debated due to similar reasons mentioned above. As an example of the implication PEF has on the reported energy performance of a building, the choice of energy source can dictate the measures taken to improve the building's energy efficiency. By choosing an energy source with low PEF for heat demand, such as using renewable biomass (with PEF of 1) instead of gas (with a relatively high PEF), the building has improved its energy efficiency manifold according to the EPBD [4]. In contrast, nothing has been done to improve the energy systems' efficiency for the building itself to achieve improvement. Although it is vital to encourage the use of efficient and clean energy resources, technological advances in the energy performance of various systems are also crucial for developing nearly zero-energy buildings and a lower-carbon future. There is a risk of using primary energy demand as a measure of a buildings' energy performance that can undermine such energy system innovation.

The EED defines the energy efficiency target of at least 32.5% by 2030. It results in the requirement that EU's "2030 energy consumption has to be no more than 1273 Mtoe of primary energy and/or no more than 956 Mtoe of final energy. This means that primary energy consumption in the Union should be reduced by 26%, and final energy consumption should be reduced by 20% compared to the 2005 levels." [23] (par. 10). As indicated by the statement of targets for primary "and/or" final energy use, the use of primary energy calculations is somewhat optional in the EED directive. Thus, Member States may choose whether to calculate energy efficiency improvements in either final or primary

energy use. In that respect, the PEF has less significant implications on different energy resources concerning the energy efficiency targets.

However, the EED does not discourage the use of primary energy as a measure, nor does it address the potential implications of the concept of primary energy on different energy resources. Since the market share of the two thermal renewable sources, geothermal and solar-thermal energies is only marginal, it is likely that the implications of the EED on these technologies have not been sufficiently assessed and addressed within the policy framework.

Additionally, since the EED equally states efficiency improvement targets for primary and final energy use, it enables the negative implications of the thermal renewables in international energy statistics reports showcasing primary energy use. Readily available global energy statistics are often used to compare national primary energy use to energy policy targets and can thus be used to draw erroneous conclusions on an alleged ill-performance of individual countries that rely on such low-efficiency renewables. An example of such erroneous conclusions is evident in Section 1.3.2 below.

#### 1.2.5. Response to Criticism on the Definition of Primary Energy Content for Renewable Energy Technologies

As previous sections describe, concerns have been raised on the use of primary energy as a basis for energy statistics, targets, and policies due to the different methodologies used to define the primary energy content. As a response to this discussion, the IEA published a commentary on the subject on its website explicitly addressing the topic. They argue that these definitions for energy resources and fuels have been based on various consultation processes involving multiple stakeholders dealing with energy statistics around the world, resulting in an agreed methodology [2]. The IEA furthermore stresses that the interpretation of energy statistics must be made with a proper understanding of the underlying assumptions and definitions that might affect what results can be extracted from these standardized and internationally agreed energy statistic methods. For interpretation of data on primary energy use, such as assessments on the share of renewables within different countries, assessments on final energy use and electricity generation should also be reviewed in context.

Here, there may have been an under-representation of thermal renewables within the consultation work process, due to their historic low market share. Also, the negative implications connected to future energy policy regarding the agreed-upon methods for defining the primary energy content of those resources may have been unforeseen. Whatever the reason, the resulting methodology on the primary energy content of thermal renewables may be criticized for being erroneous and out of sync with the definition of the primary energy content of other renewables, especially in the light of the previously mentioned implications of these definitions on the status of thermal renewables within current EU energy policy.

#### 1.3. High-Temperature Geothermal Energy in the EU's Energy Policy

In light of the above discussions on the definition of the primary energy content of various energy resources and its relevance to the EU's 2030 key energy and climate targets, the role of thermal renewable energy resources, such as geothermal and solar thermal, in the EU's future energy mix becomes particularly interesting. Since their primary energy factors become considerably higher than other PEFs for renewables, the utilization of these resources can contradict the targets aiming at improved energy efficiency in terms of primary energy use. Geothermal energy is of particular interest, as the definition of the PEF for electricity of geothermal origin generally has a value of 10 (compared to PEF of 1 for most renewable electricity), making geothermal an outlier in the values for PEFs for different energy resources and fuels.

It is typical to classify geothermal resources into high-temperature and low-temperature resources. There are multiple proposed classification methods based on various properties of the resource. In the simplest form, high-temperature geothermal resources are of volcanic origin, while low-temperature resources draw heat from the general heat flow of the earth's crust [31]. Typically,

high-temperature resources are used to produce electricity. In contrast, low-temperature resources are more suitable for direct utilization, e.g., for heating purposes, swimming and bathing, heating greenhouses, etc. However, low-temperature resources can also generate electricity by using binary cycle technology, if the temperature of the produced geothermal fluid is high enough [32]. Subsequently, high-temperature utilization often produces valuable effluent heat that can be used for the same purposes as low-temperature resources.

Geothermal power plants can be found in 11 European countries, with an installed total capacity of  $\sim 3.4$  GW<sub>el</sub>. If these plants were run on 100% capacity, they would account for only 0.4% of the net generated electricity in Europe based on data from 2017 [33]. The leading European countries in geothermal electricity generation are Turkey, Italy, and Iceland due to their access to vast high-temperature resources [34]. Direct utilization is reported in 34 European countries with around 32 GW<sub>th</sub> installed and 264,843 TJ/year of use. In fact, European countries dominate the top five countries worldwide in the direct use of geothermal in terms of MW<sub>th</sub> and TJ per land area (100 km<sup>2</sup>). Sweden, Germany, and Finland have extensive use of geothermal ground source heat pumps while Iceland, Turkey, France, Germany use geothermal resources directly for space heating. Turkey, Netherlands, Russia, and Hungary use geothermal energy to heat greenhouses and for ground heating for growing vegetables and flowers [35].

Electricity generation from geothermal resources worldwide increased by almost 30% from the year 2015 to 2020. It is further projected to increase by nearly 20% from 2020 to 2025 [34]. Direct use is growing faster than power production worldwide, as it rose more than 50% from 2015 to 2020, mostly due to a substantial increase in the installation of geothermal heat pumps, followed by an increase in utilization for space heating, bathing, and swimming. Thus, there is a growing demand for utilizing geothermal energy worldwide for producing valuable energy products with low emissions.

### 1.3.1. GHG Emissions from High-Temperature Geothermal

The utilization of geothermal resources generally results in low emissions of GHG compared to conventional energy resources (e.g., [17,36,37]). The highest emissions from geothermal exploitation stem from utilizing high-temperature resources [8]. In high-temperature geothermal reservoirs, hot fluid interacts with the surrounding rock that results in the dissolution of gases and various minerals from the rock to the geothermal fluid. The gases travel with the fluid to the plant above the surface, and are either released to the atmosphere or treated with an abatement method. These gases are mainly CO<sub>2</sub>, H<sub>2</sub>S, and CH<sub>4</sub>, yet the gas content of geothermal fluid may vary significantly between different reservoirs.

Emission values ranging from 7–740 g/kWh with a weighted average emission of 122 g/kWh have been reported for direct emissions from geothermal power plants [38]. Furthermore, the Intergovernmental Panel on Climate Change (IPCC) issued a review on published life cycle emissions for geothermal in the range of 6–79 g/kWh, where the scarcity of LCA studies on geothermal utilization likely explains the lower range reported for LCA emissions than direct emissions. GHG emissions for conventional fossil fuel generation plants are reported in the range of 833–1297 g/kWh for coal-fired plants, 386–605 g/kWh for gas-fired and 641–1462 g/kWh for oil-fired plants [39].

Extremely high CO<sub>2</sub> emission values (up to 1300 g/kWh) have, however, been reported for geothermal power plants in Turkey, resulting in higher emissions than new-generation coal power plants. These high emission factors for geothermal utilization seem to be rare and bound to high-temperature areas located in carbonate-rich rocks, such as in selected cases within Turkey, Italy, and New Zealand [40]. An example of low emission factors from high-temperature geothermal power is found in Iceland, where the average emission factor of 26 g/kWh is reported by the National Energy Authority [41].

The Renewable Energy Directive (RED) promotes geothermal energy as an important local renewable energy source but recognizes the rare cases of greenhouse gas emissions being substantial from geothermal utilization. Therefore, the RED is only intended to facilitate the development of low-emitting geothermal utilization [16].



### 1.3.2. Primary Energy Factor for Geothermal

As stated before, the PEF for geothermal electricity is defined by default as 10, representing an assumed 10% average thermal efficiency of geothermal power plants [3]. For thermal production from geothermal resources, a default conversion efficiency of 50%, resulting in a PEF of 2, is also defined by the International Energy Agency [2].

A worldwide review on the efficiency of geothermal power plants by Zarrouk and Moon [42] publishes a range of efficiencies for geothermal power production from published data from 94 plants. The study reports efficiency values as low as 1% for low-temperature geothermal utilization, and up to 21% for high-temperature utilization. Corresponding PEF values would be 100 for the lower efficiency and 4.8 for the higher efficiency values. Zarrouk and Moon [42] further concluded an average efficiency of 12% for geothermal power production, resulting in a PEF of 8.3. Thus, the default EU value for geothermal PEF is significantly higher than the efficiency statistics of current geothermal technologies would support.

Even if the default PEF for geothermal would be updated to represent reported efficiencies better, the PEF for geothermal would still be higher than most, if not all, PEFs for non-renewable energy technologies. Harmsen et al. [5] realized this and discuss how the PEF for geothermal leads automatically to increased primary energy use compared to all other energy resources, including those from fossil-fuels as they have lower PEFs than geothermal.

These negative implications of the PEF for geothermal are already finding their way into official energy statistics, as can be seen from the European Environmental Agency track report on the EU energy and climate targets [43]. The report presents an enormous increase in primary energy use in Iceland after the year 2005, thus pointing out that the country is on the wrong track regarding energy efficiency measures compared to the EU Member States. The fact is, however, that two new geothermal power plants came online in the years 2006–2012, and with a PEF of 10, they account for this substantial increase, which would have been ten times lower if the plants were, i.e., of hydropower origin (thus, with a PEF of 1). This implication of the different definitions of primary energy content to calculate the PEF is a significant factor in the criticism of using PEFs as an energy efficiency measure in policymaking, as well as compiling and publishing the national PE use in international energy statistics without clearly stating the limitations of such presentation of energy data.

### 1.3.3. Combined Heat and Power Production from High-Temperature Geothermal Resources in Context with EU's Energy Policy

Geothermal energy is particularly suited for combined heat and power (CHP) production in locations where there is access to geothermal resources in close vicinity to heat demand. Geothermal CHP plants can be found in various locations around the world, examples including Austria, Germany, Iceland, USA, and Thailand [44,45]. In these CHP cases, the challenge of a fair allocation of environmental impacts, cost, fuel/primary energy input, etc. between the two valuable products (electricity and heat) arises. The method chosen for allocation will significantly affect the outcome of the two key indicators for GHG emissions and primary energy for the electricity and heat outputs of those plants.

In CHP plants, the production of electricity and heat is so interlinked that there is no straight-forward way of partitioning inputs and outputs between them. Discussion of correct, fair, or preferred allocation method for CHP plants is both current and somewhat non-conclusive within the CHP industry, energy policy, and statistics. The three main EU directives supporting the key energy and climate targets, the RED, EED, and EPBD, include, or refer to, a discussion on allocation factors for CHP production related to the calculation of GHG emissions or the PEF.

The RED discusses the allocation of GHG emissions from CHP production and recommends using the energy allocation method. However, the EED only discusses the allocation of emissions in connection with the use of biomass fuels and bioliquids for CHP production [16]. The EED thus seems to omit the possibility of utilizing geothermal energy for CHP production. Nevertheless, it can be

assumed that the EED would recommend the use of energy allocation across all renewable energy sources used to produce CHP.

The EED focuses on the primary and end energy use and supports the energy efficiency target. The PEF is, therefore, a key indicator in context to the EED to account for the primary energy use. The EED shortly addresses the need for allocation of primary energy share to electricity from CHP plants and refers directly to Annex II to Directive 2012/27/EU for the methodology to be applied [23]. The method given in Directive 2012/27/EU is based on comparing the CHP actual production efficiencies to efficiency reference values for separate production processes of electricity and heat. Although the method is not given a title in the Annex, it is fully compatible with the so-called „Finnish method“, also called the Alternative Generation Method (AGM) [46].

The EPBD relies strongly on PEFs as they are essential to calculate the required primary energy use of a building, so allocation of primary energy in CHP production is an issue in the EPBD. The directive itself does not address the allocation issues connected to the energy supplied to a building from CHP production but refers to the calculation methodology of the ISO 52000 standard series [15]. The ISO standards that address allocation issues for CHP production are ISO 5200-1:2017 and 5100-02:2017 [25,26], with the addition of the European standard EN 15316-4-5:2017 [47]. The EN 15316 has the most elaborate discussion on allocation methods to be used for co-produced electricity and heat, and lists the following methods: Power loss method, Carnot method (comparable with the commonly used exergy method in LCA allocation procedures), Alternative production method (compatible with the AGM mentioned above), Residual heat method, and the Power loss ref method. These methods are all showcased for the allocation of the primary energy and it is not specified in the standards if they should also be used for the allocation of GHG emissions.

It is evident from the above discussion that there is a lack of consistency in the energy and climate policy framework between recommendations or requirements of allocation methodology for calculating the GHG emission factor and the PEF of electricity and heat from CHP technologies. Additionally, there is a reasonably large selection of methods given for the PEF calculations that differ significantly in their methodology. As an attempt of the authors to reach consistency between the different directive requirements or suggestions, the energy allocation method should be used to allocate GHG emissions between electricity and heat, while the AGM is a commonly suggested method for PEF calculations in both the EED and the ISO standards supporting the EPBD. The use of two different methods for the two key indicators for energy technologies, however, is not ideal and should be revised to define a single method for both indicators for further consistency between the different directives.

In the context of geothermal CHP plants, a problem arises using the AGM for allocation within high-temperature geothermal CHP plants because there is no real alternative method practiced to produce heat from high-temperature resources. Such resources are almost always used for electricity generation, or in some cases, for CHP production, but not for heat production alone.

The methods and results sections in this paper showcase the outcome of using different allocation methods, including the AGM and the energy allocation method along with other commonly used allocation methods in LCA, on the PEF and GHG emission factor for the technical example given in this study.

## 2. Materials and Methods

In the sections below, we present a technical example of the largest geothermal power plant in Iceland. The case is used in the study to evaluate the implications of the current EU energy policy using primary energy factors as a performance indicator on the future development of geothermal energy in Europe. Furthermore, the power plant also produces heat for district heating. Thus the complexity of allocation also applies to the example, giving a basis for discussion on the different methods used within the CHP industry and EU climate and energy policy for CHP plants. The example derives from a life cycle assessment study on the Hellisheidi geothermal CHP plant in Iceland, previously published by the authors in [8,48].

### 2.1. Case Study: Hellisheidi Geothermal Combined Heat and Power Plant

Hellisheidi CHP plant is located on the Hengill high-temperature area, roughly 20 km from the capital city of Reykjavik in south-west Iceland. It was built due to the increasing heat demand of the capital region, and the growing demand for electricity primarily based on the expanding aluminum industry [49]. The Hellisheidi CHP plant produces 303 MW<sub>el</sub> of power and has a current thermal capacity of 200 MW<sub>th</sub> of hot water production for district heating and hot tap water purposes. The plant has further possibilities for expansion of thermal output up to 400 MW<sub>th</sub> in the future to meet the capital's growing heat demand.

A schematic of the Hellisheidi CHP plant is given in Figure 1. The electricity generation process is a so-called double flash cycle, producing electricity from steam at two separate pressure stages (denoted in blue for the high-pressure stage and green for the low-pressure stage in Figure 1). The double flash technology allows for increased efficiency of the conversion process compared to a single pressure stage. Waste heat from the electricity generation process, as well as the available heat “leftover” from the geothermal fluid effluent, is used to heat groundwater to about 83 °C for the district heating network (process flow is shown in orange in Figure 1).

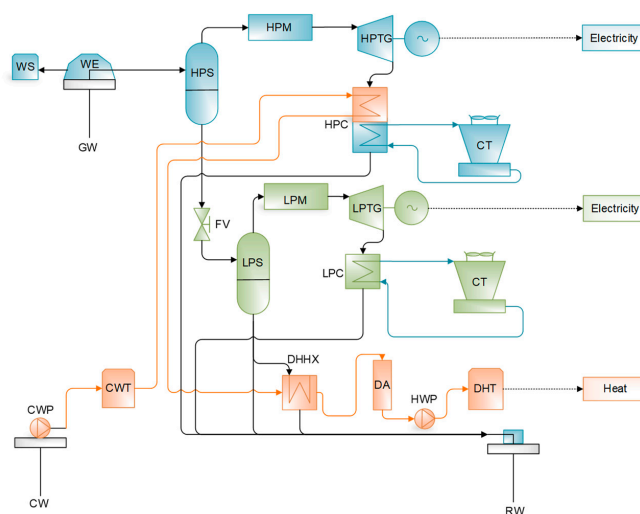

**Figure 1.** Schematic of the Hellisheidi geothermal CHP plant. WS: Well silencer; WE: Wellhead; GW: Geothermal well; HPS: High-pressure steam separator; HPM: High-pressure moisture remover; HPTG: High-pressure turbine-generator set; HPC: High-pressure condenser with preheater for district heat; CT: Cooling tower; FV: Flashing valve; LPS: Low-pressure steam separator; LPM: Low-pressure moisture remover; LPTG: Low-pressure turbine-generator set; LPC: Low-pressure condenser; CW: Coldwater well; CWP: Coldwater pump; CWT: Coldwater tank; DHHX: Heat exchanger for district heat; DA: Deaerator; HWP: Hot water pump; DHT: Hot water tank for district heat; RW: Reinjection well.

The overall electrical capacity of the plant accounts for 40% of the installed capacity from geothermal resources in Iceland while covering around 10% of the total installed capacity from hydro, geothermal, fuel (for emergency power) and wind combined, according to the Icelandic National Energy Authority [50]. For the heat demand, Hellisheidi is expected to expand gradually to meet the future demand for heat for space heating within the capital region.

### 2.2. Life Cycle Assessment (LCA) of the Hellisheidi GCHP Plant

Two detailed studies on the life cycle assessment (LCA) and the life cycle inventory (LCI) for the Hellisheidi geothermal CHP plant have been previously published by the authors [8,48].

The studies followed the methodology framework defined by the standards ISO 14040:2006 and ISO 14044:2006 [51,52].

The LCI study [48] publishes a detailed set of inventory data for Hellisheidi for the processes shown in Figure 2. The inventory was collected from primary data on the plant's construction, operation, and maintenance while using secondary data for accounting for material- and energy flow inputs retrieved from the ecoinvent v2.0 database (developed by the ecoinvent association, Zurich, Switzerland). The data set is presented such that it can be used as a reference for other LCA studies on high-temperature geothermal power and heat production processes. It allows for scaling the Hellisheidi data to suit geothermal power and heat plants with different installed capacity and different technological setups. Thus, the dataset serves as primary data for LCA of the Hellisheidi plant, but as secondary (or reference) data for potential LCA studies on other high-temperature geothermal plants.

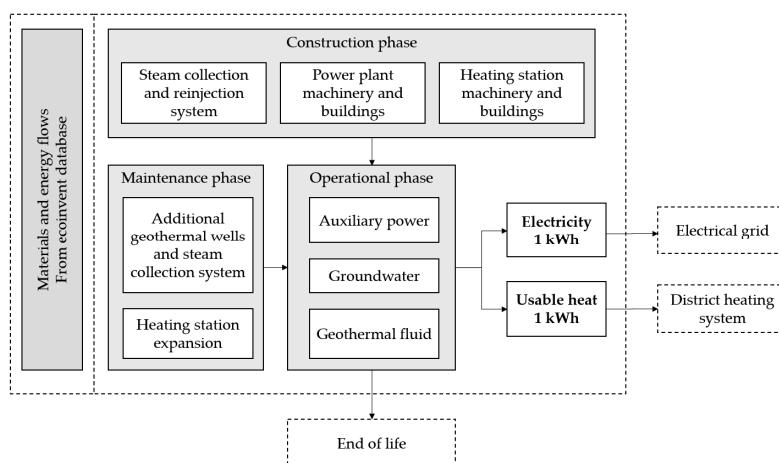

**Figure 2.** The system boundary for the Hellisheidi LCA study, showing the processes and life cycle stages included and excluded (dashed lined boxes) in the original study by Karlsdottir et al. [8].

The LCA study [8] further assesses the life cycle environmental impacts of electricity and heat production from the Hellisheidi plant. It uses the SimaPro 8 software (developed by PRé Sustainability, Amersfoort, The Netherlands) and the ecoinvent v3.4 database for data modeling and analysis. The environmental impacts were calculated using the CML-IA baseline method (developed by the Institute of Environmental Sciences, Centrum voor Milieuwetenschappen, at Leiden University, the Netherlands [28]) for GHG emissions and other environmental impact categories such as acidification potential, human toxicity, depletion of abiotic resources, etc. The cumulative energy demand (CED) method [53] was used to calculate the primary energy factors (total PEF, non-renewable PEF, and renewable PEF). Furthermore, the energy allocation method was applied (described as method C in the current study) to divide environmental impacts and CED between the two products, electricity, and heat.

The main goals of the two studies were:

- To provide a detailed dataset for high-temperature geothermal heat- and power generation technology to be used in other LCA studies as a reference, as these studies are scarce [48].
- To investigate the life cycle environmental impacts of high-temperature geothermal heat and power production [8].
- To examine the contribution of different life cycle stages of high-temperature geothermal heat- and power production to the overall environmental impacts to see if hidden impacts occur in upstream or downstream life cycle stages compared to the operational life cycle stage [8].

- To investigate the effects of operational improvements implemented during the first decade of operation of the Hellisheidi CHP plant on the overall life cycle environmental impacts compared to a base case scenario. This was done by comparing the operation scenario from 2012, where no abatement system for gaseous emissions was present, to the operation scenario from 2017 when abatement methods had been installed for gaseous emissions [8].

The system boundary for the LCA on the Hellisheidi CHP plant is shown in Figure 2. The study is a “cradle-to-gate” study as it does not include the transmission losses in electrical and district heating networks as these are outside of the scope of the study. Furthermore, the environmental impacts of the end-of-life (EOL) phase are outside the system boundary, as multiple LCA studies on geothermal power plants have shown a negligible contribution of EOL to the overall LCA results [54–56].

### 2.3. Calculation of Primary Energy Factor for Geothermal Utilization

The primary energy factor for the Hellisheidi CHP plant is evaluated by:

- (1) Calculating the primary energy content with basic thermodynamic equations based on the enthalpy (heat content) of the geothermal fluid extracted from the resource as instructed by the EU climate and energy policy framework. Since the spent geothermal fluid is reinjected back down to the reservoir after utilization within the power plant, the primary energy content of the reinjected fluid is subtracted from the extracted primary energy.
- (2) Using historical and forecasted operational input and output parameters of primary energy flow and corresponding production of electricity and heat from the plant to calculate the average PEF for the energy products over a 30-year technical lifetime scenario.
- (3) Using life cycle assessment (LCA) to account for primary energy use to extract, supply, and convert the geothermal energy to electricity and heat. LCA considers the whole value-chain within the system boundary of the power plant, as explained above in Section 2.2. The Cumulative Energy Demand (CED) method was used to calculate the final primary energy use of the power plant per produced unit of electricity and heat. The results generated by the CED method allows for a break-down of the primary energy factor into non-renewable and renewable PEFs.
- (4) Using different allocation methods to divide the primary energy input between electricity and heat outputs to calculate the separate PEF for each energy product. These are further discussed in Section 2.4.

### 2.4. Allocation of Environmental Impacts and Primary Energy Use

As with other CHP conversion cycles, some processes and equipment within the Hellisheidi CHP plant are jointly used to produce both products; electricity and heat. They will hereafter be referred to as „multifunctional processes“. The multifunctional processes at Hellisheidi CHP plant are shown within the dash-lined box in Figure 3 and described as:

- (1) Construction phase: Steam collection and reinjection system that collects, transports, and disposes of the geothermal fluid used for energy production. The processes included here are the energy and material intensive drilling activities (subsurface), as well as the well completion and the construction of the collection pipeline system for transporting the geothermal fluid above-surface.
- (2) Operational phase: Includes the use of geothermal fluid. Here, the fluid’s thermal energy content defines the primary energy form for the energy conversion cycle, and its gas- and mineral content is the cause of various potential environmental effects.
- (3) Maintenance phase: Includes drilling and completion of make-up wells for maintaining energy supply during the lifetime of the power plant. These wells sustain a constant flow of primary energy needed to produce electricity and heat, as older wells decline during production.

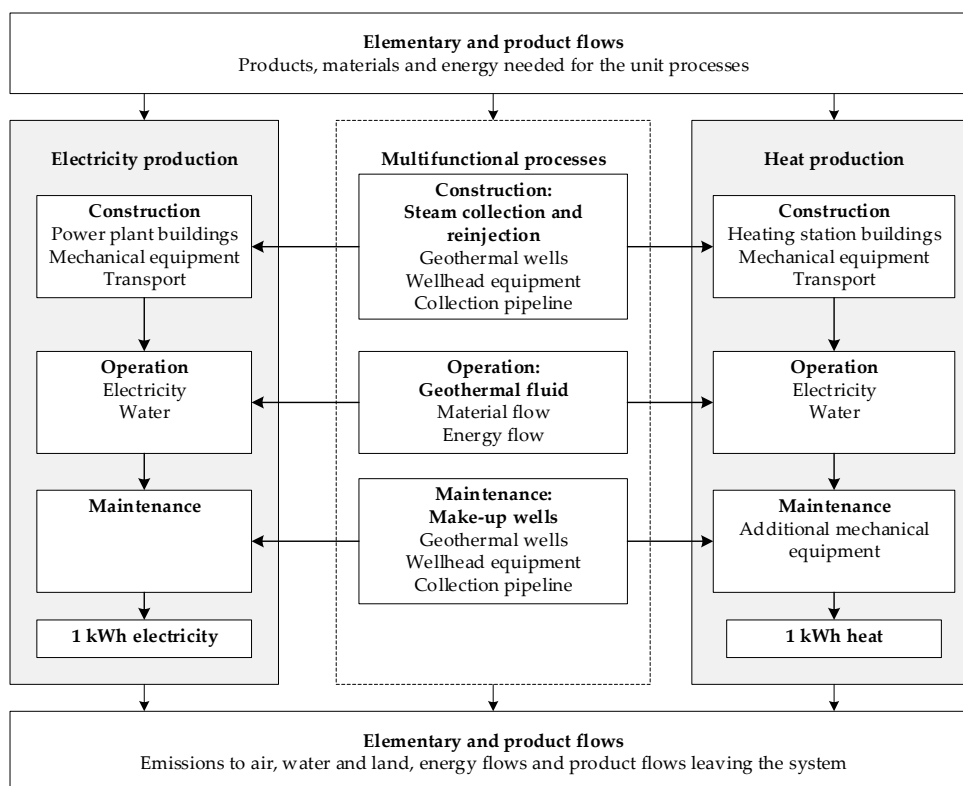

**Figure 3.** The main unit processes set up to describe the production of electricity and heat from the Hellisheidi geothermal CHP plant.

As these processes are of mutual importance to both products, an allocation method to divide the impacts originated from these processes must be selected. There are various allocation methods available, either defined within the research field of LCA or recommended within industry standards and energy policy framework, as discussed in Section 1.3.3. The allocation methods investigated in this study are presented in Sections 2.4.1–2.4.6. The selection of methods studied here is based on conventional methods used within LCA studies of CHP production, as well as applied methods in EU energy policy. The selection does not constitute a comprehensive list of possible allocation methods for CHP production, as there is a wide selection within the literature of other methods, or nuances, defined and discussed for CHP plants.

#### 2.4.1. Method A: Avoidance of Allocation with Electricity as a Primary Product

As a first priority in the ISO 14040 methodology [51], allocation should be avoided as far as possible by subdivision of multifunctional processes or system expansion. In the case of the co-production of electricity and heat in CHP plants, avoidance of allocation may, however, prove difficult. Method A is such an attempt, where allocation is avoided by system-expansion to adjust the model as if Hellisheidi was an electricity-only plant, and all processes (or part of processes) not necessary to electricity production are assigned to heat production as a by-product. This method is sometimes called “partitioning”. To execute the partitioning in the LCA model, the multifunctional processes are evaluated in detail to calculate the estimated fraction of each process necessary to produce the electricity alone. The fraction not essential to electricity production is allocated to heat.

To facilitate an electricity-only plant within the Hellsheidi LCA model, two partitioning factors are calculated. First, the steam collection and reinjection systems are fully assigned to the electricity production with the partitioning factor  $f_{A1,el}$  in Equation (2). Second, for the geothermal energy input, a specific energy transfer process between the geothermal fluid and the groundwater used for the heat production process is assigned to the heat production according to the partitioning factor  $f_{A2,el}$  in Equation (3):

$$f_{A1,el} = 1 \quad (2)$$

$$f_{A2,el} = \frac{E_{geo,HX}}{E_{geo,total}} \quad (3)$$

Here,  $E_{geo,HX}$  is the primary energy transfer between the geothermal fluid and the groundwater during the final heating process in the DHX (see Figure 1) while  $E_{geo,total}$  is the net primary energy extracted from the geothermal reservoir.

#### 2.4.2. Method B: Avoidance of Allocation with Heat as a Primary Product

Here, the same method is applied as for method A in Section 2.4.1, but with heat as a primary product of the plant. Thus, the partitioning factors are found by calculating the fraction of each multifunctional process necessary to produce heat alone. Here, calculation of three different partitioning factors, B1–B3, is needed:

- B1 For steam collection and reinjection during the construction phase: An estimation of the minimum requirement of steam collection and reinjection infrastructure to produce and sustain the heat production throughout the 30-year technical lifetime of the plant was made based on thermodynamic energy balance for stand-alone heat production and the known energy output from wells drilled at Hellsheidi. Here, it is evaluated that a minimum of five out of the 64 production wells and four out of the 17 reinjection wells would have to be drilled solely for the 133 MW<sub>th</sub> heat production that was installed during the construction phase of the CHP plant (prior to the year 2012 when operation phase is assumed to start in the study).
- B2 For geothermal fluid: The geothermal energy extraction essential for heat production is calculated separately and compared to the overall energy extraction from the geothermal fluid for the total CHP plant production to calculate the partitioning factor. However, for mass flow and direct emissions due to the use of the geothermal fluid by a heat-alone plant, the same partitioning factor is used for B1, as explained above.
- B3 For the need of make-up wells for maintaining heat production: The assumed decline of geothermal well output due to production was estimated for the maintenance phase of a stand-alone heat plant. Here, the assumption is made that at least one make-up well is needed exclusively for the maintenance of heat production at the plant over a 30-year lifetime (compared to an estimate of 15–60 make-up wells being necessary for the overall CHP plant to sustain both heat and electricity production). The assumed need for make-up wells includes future expansions above the original 133 MW<sub>th</sub> installed thermal capacity, e.g., the recent 200 MW<sub>th</sub> expansion in 2020.

The equations for the resulting partitioning factors for method B are expressed in Equations (4)–(7):

$$f_{B1,th} = \frac{N_{wells,th,con}}{N_{wells,total,con}} \quad (4)$$

$$f_{B2,th} = \frac{E_{geo,th}}{E_{geo,total}} \quad (5)$$

$$f_{B3,th} = \frac{N_{wells,th,op}}{N_{wells,total,op}} \quad (6)$$

$$f_{Bi,el} = 1 - f_{Bi,th} \quad (7)$$

where  $f_{Bi,th}$  is the partitioning factor for each multifunctional process  $i$  affected by system expansion for heat production;  $f_{Bi,el}$  is the corresponding partitioning factor for electricity production;  $N_{wells,th,con}$  is the number of wells needed for thermal production at the plant at the start of operation;

$N_{wells,th,op}$  is the amount of make-up wells needed for thermal production at the plant during a 30-year lifetime;  $N_{wells,total,con}$  is the total amount of wells needed for both electricity and thermal production at the plant at the start of operation;  $N_{wells,total,op}$  is the total amount of make-up wells needed for both electricity and thermal production at the plant for 30 years lifetime;  $E_{geo,th}$  is the primary energy extracted from the geothermal fluid to produce heat and  $E_{geo,total}$  is the net primary energy extracted from the geothermal reservoir.

#### 2.4.3. Method C: Energy Allocation

Energy, exergy, and economic allocation methods are commonly used in LCA studies of CHP plants if an allocation cannot be avoided, as they are recommended in the ISO 14040 [51]. These methods (C, D, and E) are described here and in Sections 2.4.4 and 2.4.5.

The energy allocation method (Method C) is based on the fraction of each product of the total produced energy from the plant, as described by Equations (8) and (9). It is defined as an allocation method for GHG emissions in the RED directive, as discussed in Section 1.3.3:

$$f_{C,el} = \frac{E_{el}}{E_{th} + E_{el}} \quad (8)$$

$$f_{C,th} = 1 - f_{C,el} \quad (9)$$

where  $E_{el}$  is the produced electricity [kWh] during 30-year lifetime of the plant and  $E_{th}$  is the produced heat [kWh] during 30-year lifetime of the plant.

#### 2.4.4. Method D: Exergy Allocation

Exergy allocation (Method D) is based on the fraction of the exergy content of each product compared to the overall availability of work produced from the plant. The exergy,  $X$ , is calculated by standard thermodynamic calculation methods (e.g., [57]). Equations (10) and (11) describe the calculation of the corresponding allocation factor. The exergy method is equivalent to the Carnot method suggested within the EPBD standards as discussed in Section 1.3.3:

$$f_{D,el} = \frac{X_{el}}{X_{th} + X_{el}} \quad (10)$$

$$f_{D,th} = \frac{X_{th}}{X_{th} + X_{el}} = 1 - f_{D,el} \quad (11)$$

where  $X_{el}$  is the exergy content of produced electricity during 30-year lifetime of the plant and  $X_{th}$  is the exergy content of produced heat during 30-year lifetime of the plant.

#### 2.4.5. Method E: Economic Allocation

Economic allocation (Method E) is based on the monetary value per kWh (unit purchase price) of each product at a consumer-level compared to the sum of the monetary value of both products:

$$f_{E,el} = \frac{C_{el}}{C_{th} + C_{el}} \quad (12)$$

$$f_{E,th} = \frac{C_{th}}{C_{th} + C_{el}} = 1 - f_{E,el} \quad (13)$$

where  $C_{el}$  is the unit purchase price of 1 kWh of electricity and  $C_{th}$  is the unit purchase price of 1 kWh of heat.



Using economic allocation based on unit prices is common in LCA studies (e.g., [58]). Other definitions of economic allocation could be used instead of comparing the monetary value of units of produced energy in the form of electricity and heat. Allocation based on total revenues during the lifetime of the plant, either actual reported values or estimated from unit prices and total energy production, could be used as well (e.g., [59]). In this paper, results are only presented based on unit purchase price allocation.

#### 2.4.6. Method F: Alternative Generation Method (AGM)

The Alternative Generation Method (AGM) (alternatively, the Finnish method, Alternative Production method, Benefit method, or Efficiency method) is the method most consistently referred to in EU energy policy and CHP industry standards. The method was developed by the Finnish District Heating Association and has gained popularity for fair CHP allocation as it aims to share the benefits of co-production to both products [60]. Here, two reference systems are defined as a stand-alone electricity plant and a stand-alone heat plant having default efficiencies of the energy technology in use. For geothermal energy, these default efficiencies are 10% for electricity generation and 50% for heat generation, according to the International Energy Agency [2]. Equations (14) and (15) describe the resulting allocation factors:

$$f_{F,el} = \left( \frac{E_{el}}{\eta_{alt,el}} \right) \left/ \left( \frac{E_{th}}{\eta_{alt,th}} + \frac{E_{el}}{\eta_{alt,el}} \right) \right. \quad (14)$$

$$f_{F,th} = \left( \frac{E_{th}}{\eta_{alt,th}} \right) \left/ \left( \frac{E_{th}}{\eta_{alt,th}} + \frac{E_{el}}{\eta_{alt,el}} \right) \right. = 1 - f_{F,el} \quad (15)$$

where  $E_{el}$  is the produced electricity [kWh] during 30-year lifetime of the plant;  $E_{th}$  is the produced heat [kWh] during 30-year lifetime of the plant;  $\eta_{alt,el}$  is the efficiency of the alternative electricity generation method using the same energy resource as the CHP plant and  $\eta_{alt,th}$  is the efficiency of the alternative heat generation method using the same energy resource as the CHP plant.

### 3. Results

Detailed results on the various environmental impacts based on a single select allocation method (method C. Energy allocation) can be found in Karlsdottir et al. [8]. In the present study, only results for GHG emissions and PEF are presented due to their significance within EU climate and energy policy, while also investigating the effects of choosing different allocation methods to calculate these two factors. The results show that the PEF and GHG emission factors for electricity and heat from the Hellisheidi plant do vary significantly with the different allocation methods. For electricity, the  $PEF_{el}$  ranges from 5.2–6.6 and the GHG emission factor from 15.9–21.5 g CO<sub>2</sub> eq/kWh. Consequently, the  $PEF_{th}$  varies from 1.3–5.2 and the GHG emission factor from 0.7–15.7 g CO<sub>2</sub> eq/kWh. The following sections further present the findings of allocation method selection and corresponding indicator results.

#### 3.1. Allocation Factors

As explained for methods A and B of avoided allocation, multiple partitioning factors are used in this approach, essentially one for each multifunctional process. Table 2 thus shows numerous “allocation factors” to describe the results for methods A and B, followed by a single allocation factor for each of the various allocation methods investigated in the study. The resulting allocation factors for all methods described in Section 2.4 are presented in detail in Table 2 and summarized visually in Figure 4. The results for each method are discussed in brief below.

**Table 2.** Results for the allocation factors resulting from the different allocation methods A–F investigated in the study.

Allocation Methods	Electricity	Heat
A. Electricity (system expansion)		
A1 Construction: Steam collection and reinjection	100%	0%
A2.1 Operation: Geothermal fluid, primary energy flow	94%	6%
A2.2 Operation: Geothermal fluid, material flow	100%	0%
A3 Maintenance: Make-up wells	100%	0%
B. Heat (system expansion)		
B.1 Construction: Steam collection and reinjection	86%	14%
B.2 Operation: Geothermal fluid, primary energy, and material flow	91%	9%
B.3 Maintenance: Make-up wells	97%	3%
C. Energy	73%	27%
D. Exergy	92%	8%
E. Economic	86%	14%
F. AGM	92%	8%

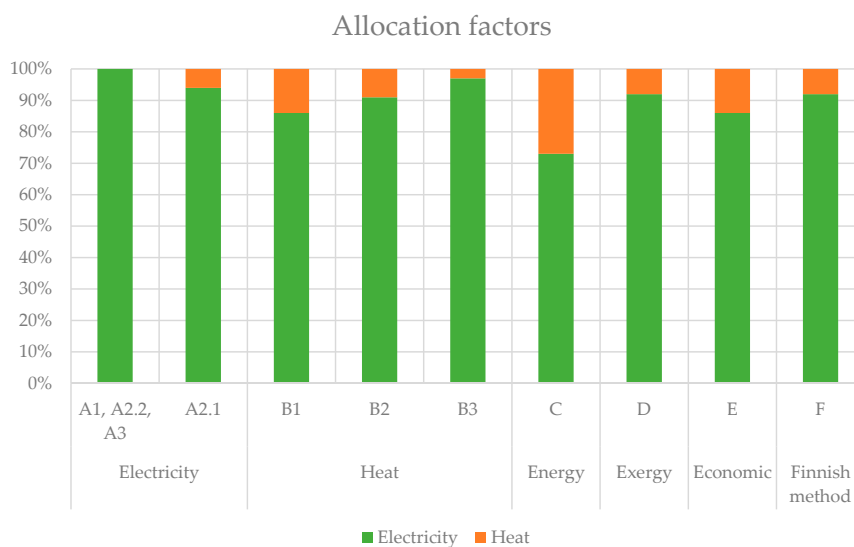
**Figure 4.** Results for allocation factors for electricity and heat from the Hellisheidi CHP plant based on the investigated allocation methods.

For method A, the only multifunctional process that was not allocated entirely to the electricity production was factor A2.1 describing the share of primary energy needed for the production. As the heat production process interlinked with the electricity production at Hellisheidi results in lower temperatures of spent geothermal fluid than if no heat production were present, the share of primary energy use corresponding to this additional primary energy use is assigned to the heat production.

For method B, it is evident by the partitioning factors in Table 2 that the heat production alone only requires a small portion of the inputs of each multifunctional process. If the Hellisheidi CHP plant had been built as a stand-alone heat plant, it would have required far a smaller number of geothermal wells and corresponding steam collection and reinjection system than the combined heat and power

production requires. This again results in lower requirements of geothermal fluid flow, fewer make-up wells needed over the plant's lifetime, etc. Thus, only the necessary contribution of each multifunction process is assigned entirely to heat production, and the rest is attributed to electricity production.

Methods C-F are conventional allocation methods producing single allocation factors based on different approaches to the allocation dilemma. The variations in the results are well noticeable in Table 2 and Figure 4. Interestingly, the Exergy method (D) and the AGM (F) produce the same allocation factors. Both these methods are listed within the EU energy and climate policy framework, as recommended methods (where method D is compatible with the Carnot method mentioned in Section 1.3.3) for partitioning the PEF between heat and electricity in CHP plants. The Energy allocation method (C) allocates the smallest fraction of environmental impacts to electricity production compared to the other methods and is thus the most beneficial for electricity. This is the recommended method for partitioning GHG emissions between electricity and heat from CHP plants, according to the RED. In contrast, the Exergy and AGM methods (D and F) allocate the most significant fraction of impacts to electricity.

To evaluate better how methods A and B affect the overall results of the division of impacts between the two products, results for the overall impact factors must be analyzed further, as done in the following section (Section 3.2).

### 3.2. Indicator Results for Electricity and Heat from Hellisheidi CHP Plant

The indicators for GHG emissions and the PEF for electricity and heat from the Hellisheidi CHP plant vary significantly between the different allocation methods used in the analysis, as seen in Figure 5. The lowest impact of electricity generation in both indicator results is achieved for allocation based on energy content (method C). This is expected since it gives the smallest allocation factor for electricity compared to the other allocation options, as discussed in Section 3.1.

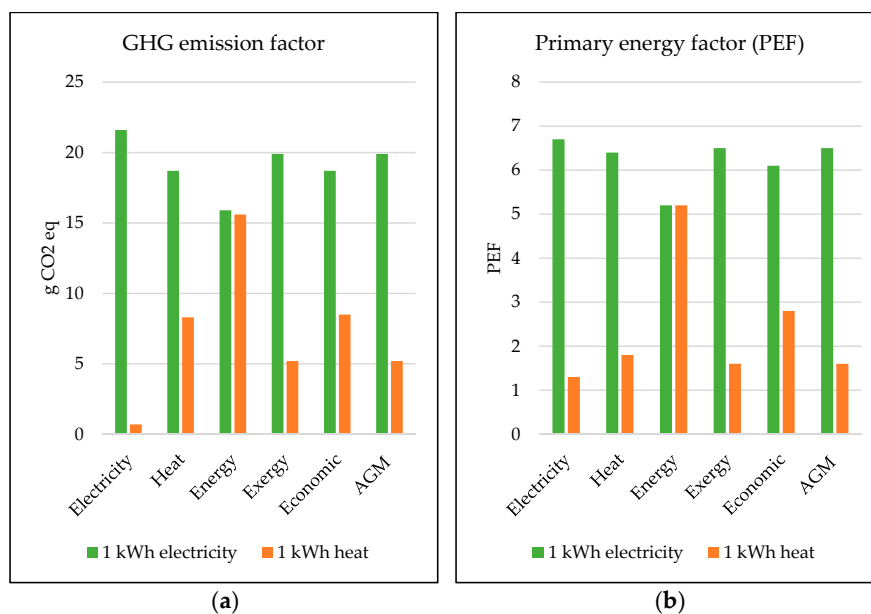
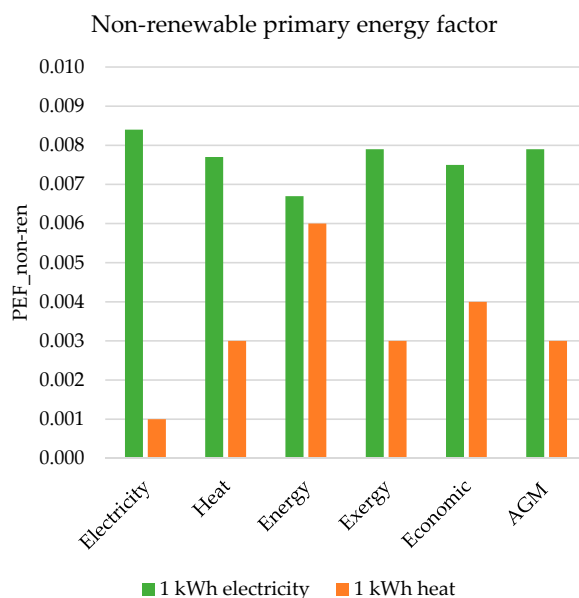

**Figure 5.** The results of the two indicators for GHG emissions and PEF vary greatly due to different allocation methods used to allocate impacts between the production of electricity and heat: (a) Results for the GHG emission factor for electricity and heat for the different allocation methods analyzed in the study; (b) The total primary energy factor shows the sum of all renewable and non-renewable energy inputs needed to produce 1 kWh of electricity or 1 kWh of heat.

Method A, with electricity as a primary product, gives the highest resulting indicators for electricity generation compared to the other allocation methods as almost all impacts resulting from the CHP plant are assigned to the electricity and only a small fraction to the heat production. The indicator values for electricity vary from 15.9–21.5 g CO<sub>2</sub> eq/kWh for the GHG emission factor and 5.2–6.6 for the PEF.

Consequently, energy allocation (method C) results in the highest indicators for heat production, while method A results in the lowest indicator results for the same reasons as discussed above. The indicator values for heat vary from 0.7–15.7 g CO<sub>2</sub> eq/kWh and 1.3–5.2 for the PEF.

As an additional note, the results for the non-renewable part of the total PEF is presented in Figure 6. Since the PEF was calculated with methods of LCA, the amount of primary energy needed for various processes throughout the lifetime of the plant has been evaluated using the cumulative energy demand (CED) impact assessment method. The sum of all non-renewable energy inputs throughout the construction, operation, and maintenance of Hellisheidi CHP plant results in the non-renewable PEF<sub>non-ren</sub> ranging from 0.007–0.009 for electricity production and 0.001–0.006 for heat production. The PEF<sub>non-ren</sub> mainly originates from the use of diesel fuel during drilling of geothermal wells, and from the production of steel for the infrastructure of the various power plant structures [8].



**Figure 6.** The non-renewable primary energy factor shows the sum of all non-renewable energy inputs (non-renewable biomass, nuclear, and fossil fuels) needed to produce 1 kWh of electricity or 1 kWh of heat. The results vary greatly depending on the allocation method used.

#### 4. Discussion

The study has reviewed the main performance indicators of the EU climate and energy policy that can influence the statistics and possible future development of geothermal energy within the EU. The critical implications are due to the definition of the primary energy content of geothermal resources and the definition of the PEF used as a key indicator in the energy policy. The PEF is a fundamental factor within the EPBD, where its use is mandatory to calculate the energy performance of buildings. At the same time, the PEF is somewhat optional in the EED, albeit primary energy use is widely discussed and highlighted within the directive as an appropriate performance indicator to account for energy efficiency measures.

As the discussion in the extensive Introduction section of this paper recaps, geothermal utilization becomes one of the most inefficient resources to utilize for energy production in terms of the primary energy factor. The reason is how the primary energy content of geothermal energy versus other renewable energy technologies is defined. Technologies such as solar photovoltaic have power conversion efficiency values (depending on technology) in the range of 11.9% for mature technologies up to 46% for developing high-efficiency technologies. The photovoltaic power systems with the highest market share have an efficiency of around 22.3% [61]. In terms of the PEF, this would translate into a PEF value of 4.5 (the inverse of the conversion efficiency), while international energy statistics define the PEF as 1 for solar photovoltaics (e.g., [2]). A PEF for photovoltaics of 4.5 is still less than the given PEF of 10 for geothermal energy. However, the two PEFs do become comparable on common ground by taking into account the actual conversion efficiencies of both technologies. This inconsistency in the primary energy definition for different renewable energy technologies favors the renewables defined with a low PEF value of 1 over the renewable thermal technologies having, by chosen definition, a much higher PEF factor implying worse energy performance in terms of primary energy efficiency. Even worse, the high PEF factors for thermal renewables also exceed PEFs for non-renewable fuels, sometimes by manifold, also implying their worse energy performance in terms of efficiency compared to the non-renewable systems. This leads to adverse effects on the use of geothermal energy as an energy source for buildings and primary energy source within a country's energy mix in context to the EU energy and climate policy framework.

The technical example of the Hellisheidi geothermal CHP plant further sheds light on the issues of defining and calculating the PEF. Since this modern, state-of-the-art plant has an electricity generation efficiency of roughly 12–14%, it is within the higher range for geothermal technologies, as presented by Zarrouk and Moon [42]. The resulting PEF for a stand-alone electricity plant at Hellisheidi is in the range of 7.1–8.3, while LCA results for the PEF fall in the range of 5.2–6.2 when a part of the primary energy use is allocated to heat production. These PEF values are considerably lower than the standard PEF of 10 for geothermal. This stresses the importance of evaluating different conversion technologies for geothermal in terms of finding standard PEFs for the different systems. Examples of different conversion technologies for geothermal are: dry steam plants, single flash plants, double flash plants, binary plants, hybrid plants, etc., each having different conversion efficiencies.

A possible solution to avoiding the bias between renewable energy technologies in terms of their attractiveness due to primary energy factors is to put more emphasis, or even specific PEF targets, on minimizing the non-renewable primary energy factor  $PEF_{\text{non-ren}}$ . For renewable technologies, the  $PEF_{\text{non-ren}}$  can be acquired using LCA or similar methods to include all up-stream energy flows needed for the life cycle of the energy conversion process. The EPBD does introduce the possibility of using multiple indicators, alongside the mandatory indicator based on primary energy, for presenting the energy performance of a building, e.g., in terms of total, non-renewable and renewable primary energy use, as well as in terms of greenhouse gas emissions. [15]. Still, the EPBD neither encourages nor implies the beneficial aspects of such a multi-factorial approach. As an example, if the  $PEF_{\text{non-ren}}$  and GHG emission factor would become mandatory within the EPBD, they would give a much broader overview of the improvement's buildings can implement without focusing solely on minimizing the overall primary energy use. For expressing those additional energy performance indicators, conversion factors (indicators) must then be available for the different energy systems to reveal the renewable and non-renewable shares of the PEF as well as the GHG emission factor. The results for the technical example in this study showed that by presenting the  $PEF_{\text{non-ren}}$  for geothermal, the beneficial elements are better highlighted in terms of the extremely low non-renewable primary energy fraction of the delivered energy product, compared to using the total PEF.

One additional complexity with geothermal energy is that GHG emissions are highly context-sensitive, and therefore the PEF alone may not be a sufficient indicator. Even if in the majority of cases, such as the Hellisheidi plant in this study, the emission intensities are on the same range as other renewables [17], the emission rates can exceed even fossil-fuel energy systems as

in individual cases in Turkey. In these cases, a possible solution is to require adequate abatement procedures (e.g., the proven carbon capture and sequestration method CarbFix [62]) or refrain from developing those geothermal resources.

Furthermore, the technical example also highlights the influence of the allocation method chosen to divide the PEF, and other indicators or environmental impacts resulting from energy production, on the resulting values. Allocation is a joint discussion within LCA research where issues often arise. Ultimately, no consensus has been reached within the LCA research field on the best allocation for energy technologies producing multiple value streams. Similarly, the EU does not recommend a specific single allocation method but gives recommendations on different methods in the RED and EED, and within the EPB standards [16,23,26]. The need for ensuring a consistent methodology for calculating PEFs, as well as energy savings and GHG emission shares of electricity and heat in CHP plants within the EU's climate and energy policy framework, is crucial.

This is especially true for high-emitting technologies as the choice of allocation method, or nuance of the same method, significantly changes the emission intensities of power and heat produced in CHP plants. The possibility of „greenwashing“ of either product is evident, by selecting an allocation method that minimizes emission intensity, e.g., of the more valuable product. An example of a nuance of a method is mentioned in Section 2.4.5 where economic allocation factors can be calculated based on different values, e.g., unit prices, actual or estimated annual revenues of a reference year, or total estimated revenues over the plant lifetime. These nuances can give drastically different results for the economic allocation factor, and often it is unclear from studies which nuance is actually used. For Hellisheiði, the variations in the economic allocation factor for electricity ranges from 70–94% if calculated based on (i) average annual revenues of heat and electricity as found in published annual reports, or (ii) the estimated revenues during the technical lifetime of the plant, based on unit prices at consumer levels and the overall expected energy production of the plant. These two nuances of economic allocation actually showcase the possibility of „greenwashing“. The lower value allocates the highest share of environmental impacts and primary energy use to heat (30%), giving similar results as allocation method C in this study, while the higher value is similar to the results for Method A, where electricity is chosen as a primary product with almost all impacts allocated to the electricity production.

From the three principal directives, two allocation methods can be highlighted above others as recommended allocation methods in EU energy and climate policy: the energy allocation method for dividing GHG emissions between electricity and heat, and the AGM for dividing the primary energy use between electricity and heat. The AGM assumes the CHP production can be substituted by corresponding separate production processes of electricity and heat, using the same form of energy resource as input to both processes. For high-temperature geothermal utilization, a separate heating production process is not a typical nor a probable production technology to be used. The capital cost of high-temperature utilization likely requires higher revenue streams for the project to be profitable than heat production alone would give. Thus electricity production is likely always the basis of high-temperature projects. That being said, it is relatively simple to use the AGM for high-temperature geothermal CHP, assuming conversion efficiencies of 10% for separate electricity generation and 50% for separate heat generation as the IAE recommends [2]. Thus, using the AGM, albeit it does not represent a likely scenario for geothermal utilization to compare the CHP production with, would result in a consistent approach to allocation for high-temperature CHP with other CHP technologies. The AGM can also be used to allocate GHG emissions and could thus serve as a single selected method for both indicators.

The energy allocation method suggested by the RED for the GHG emissions from CHP plants is a fairly simple method that is also commonly applied within LCA. It works well for allocating GHG emissions, but in the case of PEF it can result in non-representative efficiency values (equal to the inverse of the PEF as presented in Equation 1) in the context of thermodynamics. For Hellisheiði, the energy allocation results in an abnormally high PEF for heat as it normalizes the primary energy input between the kWh produced as either electricity or heat. Consequently, the high PEF for heat results in an

abnormally low efficiency of the heat production, or an efficiency of only 19% compared to the default value of 50% in energy statistics. In turn, it benefits the electricity production excessively, as a 19% efficiency value is much higher than the 12–14% actual efficiency of the electricity production at the plant. The same would apply to other CHP plants using different energy sources, as the energy method always normalises the primary energy input between the produced heat and electricity, resulting in the same dilemma of overestimating electric efficiency and underestimating thermal efficiency of heat production. Thus, the energy allocation method is not suitable for allocating PEF between electricity and heat from CHP plants.

The need for assigning an appropriate allocation method for CHP to calculate primary energy factors, energy savings, and GHG emissions from co-generated electricity and heat in context with EU energy and climate policy is of crucial importance. It would clarify which method is most appropriate and allow for comparison between different calculations of PEFs and GHG emissions from CHP plants in the EU. Taking into account the undesirable results for the PEF of electricity and heat using the energy allocation method, the AGM is more suitable as a single, consistent method that can be used to allocate different impacts between coproduction of heat and electricity.

Even though the study provided a single technical example of a specific geothermal CHP plant in Iceland, the general implication of the issues with the EU energy and climate policy also applies to other geothermal plants, whether from high- or low-temperature geothermal resources. All geothermal energy plants have relatively low thermal conversion efficiency, thus resulting in a high PEF. The results of this study can, therefore, be applied to other cases of geothermal energy utilization in terms of power production or CHP production. Geothermal energy is technically feasible for utilization in various locations around Europe (e.g., [35,63]) and has substantial potential to aid in achieving the targets of reduced emissions and increase the share of renewables within the EU's energy mix. Contrary to many other renewable energies, geothermal provides stable and reliable power output, i.e., in comparison with solar photovoltaics and wind power [63]. However, geothermal will not be a good representative of improved energy performance in terms of primary energy use if the PEF is defined the way it is described in today's EU energy and climate framework.

## 5. Conclusions

To conclude, how does geothermal utilization measure up to EU climate and energy policy? Geothermal has the potential to take part in the EU achieving its climate and energy targets. The definition of the primary energy factor, or more explicitly the primary energy content of a geothermal resource, does limit geothermal energy for being successful in terms of improved energy efficiency measures unless the measures are against lowering the non-renewable primary energy use instead of the total primary energy use. The authors regard that the intention of the IEA with the different definitions on how to evaluate the primary energy of a resource was not to cause biased energy indicators that could potentially favor non-renewable technologies in some context over some renewables. Still, the PEF for thermal renewables does precisely that. It may be that the downside implications resulting from the PEF definition for geothermal utilization were not taken sufficiently into account in the process. We believe that the most transparent way of expressing the benefits of replacing non-renewable energy with renewable energy in terms of primary energy efficiency is to highlight the  $PEF_{\text{non-ren}}$  as a mandatory indicator within the EU "Clean energy for all Europeans" policy framework.

**Author Contributions:** Conceptualization, M.R.K., J.H., H.P., and O.P.P.; methodology, M.R.K. and J.H.; software, M.R.K.; validation, M.R.K.; formal analysis, M.R.K.; investigation, M.R.K.; resources, M.R.K.; data curation, M.R.K.; writing—original draft preparation, M.R.K.; writing—review and editing, M.R.K., J.H., H.P., and O.P.P.; visualization, M.R.K.; supervision, O.P.P.; project administration, O.P.P.; funding acquisition, O.P.P. All authors have read and agreed to the published version of the manuscript.

**Funding:** This work is a part of the Primary Energy Efficiency (PEE) project that was funded by Nordic Energy Research, grant number 16X753.02, and co-financed by the National Energy Fund (Orkusjóður), grant number

12-2007, owned by the Government of Iceland. Also partially funded by the Landsvirkjun Energy Research fund, grant number FMV 04-2013.

**Acknowledgments:** Reykjavik Energy, and its subsidiary ON Power, supported the work by providing data on the Hellisheidi geothermal CHP plant along with expert advice.

**Conflicts of Interest:** The funders had no role in the design of the study; in the collection, analyses, or interpretation of data; in the writing of the manuscript, or in the decision to publish the results.

## Abbreviations

ACER	Agency for the Cooperation of Energy Regulators
AGM	Alternative Generation Method
CED	Cumulative Energy Demand
CEN	The European Committee for Standardization (French: Comité Européen de Normalisation)
CHP	Combined Heat and Power
CML-IA	Impact Assessment method of the Centrum voor Milieuwetenschappen, Leiden University
CT	Cooling tower
CW	Coldwater well
CWP	Coldwater pumps
CWT	Coldwater tank
DA	Deaerator
DHHX	Heat exchanger District Heat
DHT	Hot water tank District Heat
ED	Electricity Directive
EED	Energy Efficiency Directive
EOL	End of life
EPB	Energy Performance in Buildings
EPBD	Energy Performance in Buildings Directive
EPC	Energy Performance Certificate
ETS	Emission Trading System
EU	European Union
FV	Flashing valve
GHG	Greenhouse Gas Emissions
GW	Geothermal well
HPC	High-pressure condenser with preheater
HPM	method moisture remover
HPS	High-pressure steam separator
HPTG	High-pressure turbine-generator set
HWP	Hot water pump
IEA	International Energy Agency
IPCC	Intergovernmental Panel on Climate Change
IRES	International Recommendations for Energy Statistics
ISO	International Organization for Standardization
LCA	Life Cycle Assessment
LCI	Life cycle inventory
LPC	Low-pressure condenser
LPM	Low-pressure moisture remover
LPS	Low-pressure steam separator
LPTG	Low-pressure turbine-generator set
PEF	Primary Energy Factor
PEF <sub>non-ren</sub>	Non-Renewable Primary Energy Factor
RED	Renewable Energy Directive
RW	Reinjection well
WE	Wellhead
WS	Well silencer



## References

1. European Commission. *Clean Energy for All Europeans Package*. Available online: <https://ec.europa.eu/energy/en/topics/energy-strategy-and-energy-union/clean-energy-all-europeans> (accessed on 21 November 2019).
2. International Energy Agency. *Commentary: Understanding and Using the Energy Balance*. Available online: [https://www.iea.org/newsroom/news/2017/september/commentary-understanding-and-using-the-energy-balance.html?utm\\_content=buffer3537d](https://www.iea.org/newsroom/news/2017/september/commentary-understanding-and-using-the-energy-balance.html?utm_content=buffer3537d) (accessed on 26 November 2019).
3. Eurostat. *Energy Balance Guide. Methodology Guide for the Construction of Energy Balances & Operational Guide for the Energy Balance Builder Tool*. Available online: <https://ec.europa.eu/eurostat/documents/38154/4956218/ENERGY-BALANCE-GUIDE-DRAFT-31JANUARY2019.pdf/cf121393-919f-4b84-9059-cdf0f69ec045> (accessed on 26 November 2019).
4. Buildings Performance Institute Europe. *Is the Primary ENERGY factor the Right Indicator for Determining the Energy Performance of Buildings? Discussion Paper*. Available online: [http://bpie.eu/wp-content/uploads/2017/09/Policy-paper-PEF\\_edits\\_18Sept.pdf](http://bpie.eu/wp-content/uploads/2017/09/Policy-paper-PEF_edits_18Sept.pdf) (accessed on 22 November 2019).
5. Harmsen, R.; Wesseling, B.; Eichhammer, W.; Worrell, E. The unrecognized contribution of renewable energy to Europe's energy savings target. *Energy Policy* **2011**, *39*, 3425–3433. [CrossRef]
6. Hitchin, R. Primary Energy Factors and the primary energy intensity of delivered energy: An overview of possible calculation conventions. *Build. Serv. Eng. Res. Technol.* **2018**, *40*, 014362441879971. [CrossRef]
7. Segers, R. Three options to calculate the percentage renewable energy: An example for a EU policy debate. *Energy Policy* **2008**, *36*, 3243–3248. [CrossRef]
8. Karlsdottir, M.R.; Heinonen, J.; Palsson, H.; Palsson, O.P. Life cycle assessment of a geothermal combined heat and power plant based on high temperature utilization. *Geothermics* **2020**, *84*, 101727. [CrossRef]
9. Eurostat. *Smarter, Greener, More Inclusive? Indicators to Support the Europe 2020 Strategy*, 2019 eds.; Publication Office of the European Union: Luxembourg, 2019.
10. European Commission. *Communication from the Commission to the European Parliament, the Council, the European Economic and Social Committee and the Committee of the Regions. A Policy Framework for Climate and Energy in the Period from 2020 to 2030*; Publication Office of the European Union: Luxembourg, 2014.
11. European Commission. *2030 Climate & Energy Framework*. Available online: [https://ec.europa.eu/clima/policies/strategies/2030\\_en](https://ec.europa.eu/clima/policies/strategies/2030_en) (accessed on 21 November 2019).
12. Directorate-General for Energy, *Clean Energy for All Europeans*; Publication Office of the European Union: Luxembourg, 2019.
13. European Commission The European Green Deal. Available online: [https://ec.europa.eu/commission/presscorner/detail/e%20n/ip\\_19\\_6691](https://ec.europa.eu/commission/presscorner/detail/e%20n/ip_19_6691) (accessed on 17 April 2020).
14. European Commission, Directorate-General for Climate Action. *Proposal for a regulation of the European Parliament and of the Council establishing the framework for achieving climate neutrality and amending Regulation (EU) 2018/1999 (European Climate Law)*; Publication Office of the European Union: Brussels, Belgium, 2020.
15. European Council Directive. *Directive (EU) 2018/844 of the European Parliament and of the Council of 30 May 2018 Amending Directive 2010/31/EU on the Energy Performance of Buildings and Directive 2012/27/EU on Energy Efficiency (Text with EEA Relevance)*; European Parliament and European Council, Ed.; Official Journal of the European Union: Luxembourg, 2018.
16. European Council Directive. *Directive (EU) 2018/2002 of the European Parliament and of the Council of 11 December 2018 on the Promotion of the Use of Energy from Renewable Sources (Recast)*; Official Journal of the European Union: Luxembourg, 2018.
17. Cherubini, F.; Birda, N.; Cowie, A.; Jungmeier, G.; Schlamadinger, B.; Woess-Gallasch, S. Energy- and greenhouse gas-based LCA of biofuel and bioenergy systems: Key issues, ranges and recommendations. *Resour. Conserv. Recycl.* **2009**, *53*, 434–447. [CrossRef]
18. Heinonen, J.; Laine, J.; Pluuman, K.; Säynäjoki, E.-S.; Soukka, R.; Junnila, S. Planning for a Low Carbon Future? Comparing Heat Pumps and Cogeneration as the Energy System Options for a New Residential Area. *Energies* **2015**, *8*, 9137–9154. [CrossRef]
19. Olkkonen, V.; Syri, S. Spatial and temporal variations of marginal electricity generation: The case of the Finnish, Nordic, and European energy systems up to 2030. *J. Clean. Prod.* **2016**, *126*, 515–525. [CrossRef]

20. Zhang, X.; Myhrvold, N.P.; Caldeira, K. Key factors for assessing climate benefits of natural gas versus coal electricity generation. *Environ. Res. Lett.* **2014**, *9*, 114022. [[CrossRef](#)]
21. Farsaei, A.; Syri, S.; Olkkonen, V.; Khosravi, A. Unintended Consequences of National Climate Policy on International Electricity Markets—Case Finland’s Ban on Coal-Fired Generation. *Energies* **2020**, *13*, 1930. [[CrossRef](#)]
22. Soimakallio, S.; Kiviluoma, J.; Saikku, L. The complexity and challenges of determining GHG (greenhouse gas) emissions from grid electricity consumption and conservation in LCA (life cycle assessment)—A methodological review. *Energy* **2011**, *36*, 6705–6713. [[CrossRef](#)]
23. European Council Directive. *Directive (EU) 2018/2002 of the European Parliament and of the Council of 11 December 2018 Amending Directive 2012/27/EU on Energy Efficiency*; Official journal of the European Union: Luxembourg, 2018.
24. Bio Intelligence Service; Ronan Lyons. *IEEP Energy Performance Certificates in Buildings and Their Impact on Transaction Prices and Rents in Selected EU Countries. Final Report Prepared for European Commission (DG Energy)*; Publication Office of the European Union: Brussels, Belgium, 2013.
25. International Organization for Standardization. *Energy Performance of Buildings—Overarching EPB Assessment—Part 1: General Framework and Procedures (ISO 52000-1:2017)*; International Organization for Standardization: Geneva, Switzerland, 2017.
26. European committee for standardization. *Energy Performance of Buildings - Overarching EPB Assessment—Part 2: Explanation and Justification of ISO 52000-1 (CEN ISO/TR 52000-2:2017)*; International Organization for Standardization: Geneva, Switzerland, 2017.
27. Curran, M.A.; Mann, M.; Norris, G. The international workshop on electricity data for life cycle inventories. *J. Clean. Prod.* **2005**, *13*, 853–862. [[CrossRef](#)]
28. Guinée, J.B.G.M.; Heijungs, R.; Huppes, G.; Kleijn, R.; de Koning, A.; van Oers, L.; Wegener Sleeswijk, A.; Suh, S.; Udo de Haes, H.A.; de Bruijn, H.; et al. *Handbook on Life Cycle Assessment. Operational Guide to the ISO Standards. I: LCA in Perspective. Ila: Guide. Iib: Operational Annex. III: Scientific Background*; Kluwer Academic Publishers: Dordrecht, The Netherlands, 2002; p. 692.
29. Guinée, J.B.; Heijungs, R.; Huppes, G.; Zamagni, A.; Masoni, P.; Buonamici, R.; Ekvall, T.; Rydberg, T. Life cycle assessment: Past, present, and future. *Environ. Sci. Technol.* **2011**, *45*, 90–96. [[CrossRef](#)] [[PubMed](#)]
30. Sauar, E. IEA Underreports Contribution Solar and Wind by A Factor of Three Compared to Fossil Fuels. Available online: <https://energypost.eu/iea-underreports-contribution-solar-wind-factor-three-compared-fossil-fuels/> (accessed on 25 November 2019).
31. Saemundsson, K.; Axelsson, G.; Steingrímsson, B. *Geothermal Systems in Global Perspective*; ISOR – Iceland GeoSurvey Reykjavik: Reykjavik, Iceland, 2009.
32. DiPippo, R. *Geothermal Power Plants. Principles, Applications, Case Studies and Environmental Impact*; Elsevier: Amsterdam, The Netherlands, 2008.
33. Eurostat Statistics Explained. Electricity Production, Consumption and Market Overview. Available online: [https://ec.europa.eu/eurostat/statistics-explained/index.php/Electricity\\_production,\\_consumption\\_and\\_market\\_overview#:~:{}:text=Data%20extracted%20in%20June%202019,Planned%20article%20update%3A%20July%202020.&text=Total%20net%20electricity%20generation%20in,2017%20came%20from%20combustible%20fuels](https://ec.europa.eu/eurostat/statistics-explained/index.php/Electricity_production,_consumption_and_market_overview#:~:{}:text=Data%20extracted%20in%20June%202019,Planned%20article%20update%3A%20July%202020.&text=Total%20net%20electricity%20generation%20in,2017%20came%20from%20combustible%20fuels) (accessed on 5 June 2020).
34. Hutterer, G.W. Geothermal Power Generation in the World 2015-2020 Update Report. In *World Geothermal Congress*; International Geothermal Association: Reykjavik, Iceland, 2020.
35. Lund, J.W.; Toth, A.N. Direct Utilization of Geothermal Energy 2020 Worldwide Review. In *World Geothermal Congress*; International Geothermal Association: Reykjavik, Iceland, 2020.
36. Sullivan, J.L.; Wang, M.Q. Life cycle greenhouse gas emissions from geothermal electricity production. *J. Renew. Sustain. Energy* **2013**, *5*, 063122. [[CrossRef](#)]
37. Saner, D.; Juraske, R.; Kubert, M.; Blum, P.; Hellweg, S.; Bayer, P. Is it only CO<sub>2</sub> that matters? A life cycle perspective on shallow geothermal systems. *Renew. Sustain. Energy Rev.* **2010**, *14*, 1798–1813. [[CrossRef](#)]
38. Bertani, R.; Thain, I. Geothermal power generating plant CO<sub>2</sub> emission survey. *IGA News*, 20 September 2002; pp. 1–3.

39. Hussy, C.; Klaassen, E.; Koornneef, J.; Wigand, F. *International Comparison of Fossil Power Efficiency and CO<sub>2</sub> Intensity*; Ecofys: Utrecht, The Netherlands, 2014.
40. Fridriksson, T.; Mateos, A.; Orucu, Y.; Audinet, P. Greenhouse Gas Emissions from Geothermal Power Production. In *Stanford Geothermal Workshop*; Stanford Geothermal Workshop: Stanford, CA, USA, 2017.
41. Orkustofnun. OS-2019-T004-01: *Gas Emissions of Geothermal Power Plants and Utilities 1969–2018*; Orkustofnun: Reykjavik, Iceland, 2019.
42. Zarrouk, S.J.; Moon, H. Efficiency of geothermal power plants: A worldwide review. *Geothermics* **2014**, *51*, 142–153. [[CrossRef](#)]
43. European Environment Agency. *Trends and Projections in Europe 2019. Tracking Progress towards Europe's Climate and Energy Targets*; 15/2019; Publication Office of the European Union: Luxembourg, 2019.
44. Lund, J.W.; Chiasson, A. Examples of combined heat and power plants using geothermal energy. In *European Geothermal Congress (EGC)*; European Geothermal Energy Council (EGEC): Unterhaching, Germany, 2007.
45. DeLovato, N.; Sundarnath, K.; Cvijovic, L.; Kota, K.; Kuravi, S. A review of heat recovery applications for solar and geothermal power plants. *Renew. Sustain. Energy Rev.* **2019**, *114*, 109329. [[CrossRef](#)]
46. EPD INTERNATIONAL AB. *Product Category Rules (PCR). Electricity, Steam and Hot Water Generation and Distribution*; 2007:08; EPD International AB: Stockholm, Sweden, 2020.
47. European Committee for Standardization. *EN 15316-4-5:2017 (E). Heating Systems in Buildings - Method for Calculation of SYSTEM energy Requirements and System Efficiencies—Part 4–5: District Heating and Cooling*; International Organization for Standardization: Geneva, Switzerland, 2017.
48. Karlsdottir, M.R.; Palsson, H.; Palsson, O.P.; Maya-Drysdale, L. Life cycle inventory of a flash geothermal combined heat and power plant located in Iceland. *Int. J. Life Cycle Assess.* **2015**, *20*, 503–519. [[CrossRef](#)]
49. Gunnlaugsson, E.; Gislason, G. *Preparation for a New Power Plant in the Hengill Geothermal Area, Iceland In World Geothermal Congress*; International Geothermal Association: Antalya, Turkey, 2005.
50. National Energy Authority. *Energy Statistics in Iceland 2016*; Orkustofnun National Energy Authority: Reykjavik, Iceland, 2017.
51. ISO 14040. *Environmental Management-Life Cycle Assessment-Principles and Framework (ISO 14040:2006)*; ISO-International Organization for Standardization: Geneva, Switzerland, 2006.
52. ISO 14044. *Environmental Management-Life Cycle Assessment-Requirements and Guidelines (ISO 14044:2006)*; ISO-International Organization for Standardization: Geneva, Switzerland, 2006.
53. Hischier, R.; Weidema, B.; Althaus, H.J.; Bauer, C.; Doka, G.; Dones, R.; Frischknecht, R.; Hellweg, S.; Humbert, S.; Jungbluth, N. *Implementation of Life Cycle Impact Assessment Methods. Ecoinvent Report No. 3, v2.2*; ecoinvent Centre: Dübendorf, Switzerland, 2010.
54. Sullivan, J.L.; Stephens, T.; Wang, M. *Geothermal Power Production: Alternative Scenarios and Critical Issues*; Argonne National Lab. (ANL): Lemont, IL, USA, 2014.
55. Buonocore, E.; Vanoli, L.; Carotenuto, A.; Ulgiati, S. Integrating life cycle assessment and emergy synthesis for the evaluation of a dry steam geothermal power plant in Italy. *Energy* **2015**, *86*, 476–487. [[CrossRef](#)]
56. Frick, S.; Kaltschmitt, M.; Schroder, G. Life cycle assessment of geothermal binary power plants using enhanced low-temperature reservoirs. *Energy* **2010**, *35*, 2281–2294. [[CrossRef](#)]
57. Ertesvåg, I.S. Exergetic comparison of efficiency indicators for combined heat and power (CHP). *Energy* **2007**, *32*, 2038–2050. [[CrossRef](#)]
58. Moretti, C.; Corona, B.; Rühlin, V.; Götz, T.; Junginger, M.; Brunner, T.; Obernberger, I.; Shen, L. Combining Biomass Gasification and Solid Oxid Fuel Cell for Heat and Power Generation: An Early-Stage Life Cycle Assessment. *Energies* **2020**, *13*, 2773. [[CrossRef](#)]
59. Lelek, L.; Kulczycka, J.; Lewandowska, A.; Zarebska, J. Life cycle assessment of energy generation in Poland. *Int. J. Life Cycle Assess.* **2016**, *21*, 1–14. [[CrossRef](#)]
60. Tereshchenko, T.; Nord, N. Uncertainty of the allocation factors of heat and electricity production of combined cycle power plant. *Appl. Therm. Eng.* **2015**, *76*, 410–422. [[CrossRef](#)]
61. Shubbak, M.H. Advances in solar photovoltaics: Technology review and patent trends. *Renew. Sustain. Energy Rev.* **2019**, *115*, 109383. [[CrossRef](#)]

62. Aradóttir, E.S.P.; Gunnarsson, I.; Sigfússon, B.; Gunnarsson, G.; Júlíusson, B.M.; Gunnlaugsson, E.; Sigurdardóttir, H.; Arnarson, M.T.; Sonnenthal, E. Toward Cleaner Geothermal Energy Utilization: Capturing and Sequestering CO<sub>2</sub> and H<sub>2</sub>S Emissions from Geothermal Power Plants. *Transp. Porous Media* **2015**, *108*, 61–84. [[CrossRef](#)]
63. Khosravi, A.; Syri, S.; Zhao, X.; El Haj Assad, M. An Artificial Intelligence Approach for Thermodynamic Modeling of Geothermal Based-Organic Rankine Cycle Equipped with Solar System. *Geothermics* **2019**, *80*, 138–154. [[CrossRef](#)]



© 2020 by the authors. Licensee MDPI, Basel, Switzerland. This article is an open access article distributed under the terms and conditions of the Creative Commons Attribution (CC BY) license (<http://creativecommons.org/licenses/by/4.0/>).

